



JDENTAL CARE
just smile

SURGICAL KITS AND INSTRUMENTS

We make innovative surgical instruments to improve the daily practice of clinicians



Made in Italy

INDEX OF THE PRODUCTS

Surgical Kits:

• Standard Kits

JD Surgical Kit	06
JDPad Surgical Kit	10
JD Bone Track™ Drills Kit	14
JD Onedrill Kit	16

• Guided Surgery Kits

JD Guided Surgery Kit	18
JD Extra Drills Kit	22

• Maxilla-For-All® Kits

JD Pterygo Surgical Kit	24
JDPterygo Drills Kit	26
JDNasal Kit	27
JDZygoma Kit	28

Surgical Instruments:

JDGuide	34
JDTorque	36
Bone Mill	37
Tissue Punch	37
Surgical Drivers	38
Direction Indicators	38
Aligning Instruments	39
Depth Probes	39
JD Removal and Repair Tools	40
JDWeld	42

Drilling Protocols:

Non Guided Surgery	46
Guided Surgery	54

Summary tables:

All The Drills	60
All The instruments	64

SURGICAL KITS

Standard Kits

JD Surgical Kit	06
JDPad Surgical Kit	10
JD Bone Track™ Drills Kit	14
JD Onedrill Kit	16

Guided Surgery Kits

JD Guided Surgery Kit	18
JD Extra Drills Kit	22

Maxilla-For-All® Kits

JD Pterygo Surgical Kit	24
JDPterygo Drills Kit	26
JDNasal Kit	27
JDZygoma Kit	28

Product Code: JDPS - JDPCN

Compact and easy to use

The JD Surgical Kit is a compact and easy-to-use kit, that can be washed and sterilised, as it is tested to withstand autoclave cycles.

The kit is available in two versions: with and without drill stops; choose the kit that best suits your surgery.



JD Surgical Kit
Plastic Kit Standard
Code: JDPS

Drills:

JDPD	Precision Drill
JDDR20	Twist Drill Ø 2.0
JDDR24	Twist Drill Ø 2.4
JDDR28	Twist Drill Ø 2.8
JDDR32	Twist Drill Ø 3.2
JDDR36	Twist Drill Ø 3.6
JDDR40	Twist Drill Ø 4.0
JDDR44	Twist Drill Ø 4.4
JDDR48*	Twist Drill Ø 4.8
JDDREXT	Drill Extension

*To be ordered separately



Implant and prosthetic drivers:

JDTW	Torque Wrench JDTorque
JDTWA	Surgical Adapter for JDTorque

Note: all prosthetic drivers will be provided compatible with the chosen implant line.



Direction indicators:

JDDI	Direction Indicator
JDDIS	Direction Indicator Short



Product Code: JDPS - JDPCN



JD Surgical Kit w/ Drill Stops
Plastic Kit w/ Drill Stops
Code: JDPCN

This kit has the same products as JD Surgical base kit, except for the drills that are replaced with the one with stops, and Drill Stops are added

Drills:

JDDR20C	Twist Drill with Stop Ø 2.0
JDDR24C	Twist Drill with Stop Ø 2.4
JDDR28C	Twist Drill with Stop Ø 2.8
JDDR32C	Twist Drill with Stop Ø 3.2
JDDR36C	Twist Drill with Stop Ø 3.6
JDDR40C	Twist Drill with Stop Ø 4.0
JDDR44C	Twist Drill with Stop Ø 4.4
JDDR48C*	Twist Drill with Stop Ø 4.8

*To be ordered separately

Drill stops:

JDDRST60N	Drill Stop New L 6
JDDRST80N	Drill Stop New L 8
JDDRST100N	Drill Stop New L 10
JDDRST115N	Drill Stop New L 11.5
JDDRST130N	Drill Stop New L 13
JDDRST150N	Drill Stop New L 15



Drills:

In the first line of the JD Surgical Kit are located the twist drills and the drill extension, used for the implant site preparation. On the body of the twist drills there are depth marks and in particular a larger mark from 10 mm to 11.5 mm. To ensure optimal primary stability of the implant it is recommended to adhere to the indications of the drilling sequence as indicated on the brochures of each implant line, available at: www.jdentalcare.com.

The twist drills inserted in the Surgical kits are also characterized by a DLC coating, which has the following advantages:

- When the surgical drills are running at high speed, the DLC coating makes the depth marks on drills clearly visible for easier practical use.
- The DLC coating has excellent wear and corrosion resistance.
- The DLC coating reduces friction, resulting in minimal heating of the bone during implant osteotomy.

The steps for a correct osteotomy:

1. Choose the correct implant length
2. Analyze the bone type: if it is soft, medium or dense
3. Follow the indication of the drilling sequence, according to the bone type and implant chosen
4. Check the length of the twist drills on the bottom right-hand corner of the surgical kit

Note: To place the JD Implant Ø6.0, it is necessary to buy separately the appropriate surgical drill Ø4.8 not present in the standard Kit version

Implant drivers:

On the left of the JD Surgical Kit two implant drivers, one short and one long, are included. We will provide you with the compatible driver according to the chosen implant line.

Important: To simplify the final prosthetic rehabilitation, at the time of the final placement of the implant, when the desired depth has been reached, it is necessary to align the side of the hexagon and not the vertex in the implant driver with the vestibular side. In this way, the hexagonal shape of the internal connection makes it possible to position and orient the prosthetic abutment in an optimal manner.



Prosthetic Screwdrivers:

The JD Surgical Kit includes also two screwdrivers for the prosthetic screws, the cover screws, impression copings screws. These screwdrivers are designed to be used both manually and with JD Torque wrench. We will provide you with the prosthetic screwdriver according to the chosen implant line.



JD Torque:

JD Torque is the manual torque wrench manufactured by JDentalCare. It enables you to manually insert, tighten and/or loosen JDentalCare implants, abutments and prosthetic screws, achieving a specific value of torque. Tightening torques range from 10 to 80 Ncm.



Surgical Adaptor:

The surgical adaptor is used with the appropriate implant driver for a manually implant insertion. When it is not possible to go ahead manually with implant insertion, insert the adaptor into the JD Torque device to screw the implant into its final position.



Direction indicators:

The kit includes two direction indicators, one short 10mm length and one long 15mm length. These tools shall be used after the drill Ø 2.0mm. These instruments have also marks to measure the depth of the implant site.



Drill stop:

This devices are used with the drill to limit the drilling depth to a predefined value, during the preparation of the implant site.



Product Code: EVPS - EVPCN

Compact and easy to use

The JDPad surgical kit consists of a silicone body and an aluminium lid. This kit can be disassembled, washed and sterilised, as it is tested to withstand autoclave cycles.

The kit is available in two versions: with and without drill stops. Choose the kit that best suits your surgery.



JDPad Surgical Kit
JDPad Standard
Code: EVPS

Drills:

JDPD	Precision Drill
JDDR20	Twist Drill Ø 2.0
JDDR24	Twist Drill Ø 2.4
JDDR28	Twist Drill Ø 2.8
JDDR32	Twist Drill Ø 3.2
JDDR36	Twist Drill Ø 3.6
JDDR40	Twist Drill Ø 4.0
JDDR44	Twist Drill Ø 4.4
JDDR48*	Twist Drill Ø 4.8
JDDREXT	Drill Extension New

*To be ordered separately



Implant and prosthetic drivers:

JDTW	Torque Wrench JD Torque
JDTWA	Surgical Adapter for JD Torque

Note: All prosthetic drivers will be provided compatible with the chosen implant line.



Direction indicators:

JDDI	Direction Indicator
JDDIS	Direction Indicator Short



Product Code: EVPS - EVPCN



JDPad Surgical Kit w/ Drill Stops
 JDPad w/ Drill Stops
 Code: EVPCN

This kit has the same products as JDPad Surgical Kit, except for the drills that are replaced with the one with stops, and Drill Stops are added

Drills:

JDDR20C	Twist Drill with Stop Ø 2.0
JDDR24C	Twist Drill with Stop Ø 2.4
JDDR28C	Twist Drill with Stop Ø 2.8
JDDR32C	Twist Drill with Stop Ø 3.2
JDDR36C	Twist Drill with Stop Ø 3.6
JDDR40C	Twist Drill with Stop Ø 4.0
JDDR44C	Twist Drill with Stop Ø 4.4
JDDR48C*	Twist Drill with Stop Ø 4.8

*To be ordered separately

Drill stops:

JDDRST60N	Drill Stop New L 6
JDDRST80N	Drill Stop New L 8
JDDRST100N	Drill Stop New L 10
JDDRST115N	Drill Stop New L 11.5
JDDRST130N	Drill Stop New L 13
JDDRST150N	Drill Stop New L 15



Drills:

In the first line of the JD Surgical Kit are located the twist drills and the drill extension, used for the implant site preparation. On the body of the twist drills there are depth marks and in particular a larger mark from 10 mm to 11.5 mm. To ensure optimal primary stability of the implant it is recommended to adhere to the indications of the drilling sequence as indicated on the brochures of each implant line, available at: www.jdentalcare.com.

The twist drills inserted in the Surgical kits are also characterized by a DLC coating, which has the following advantages:

- When the surgical drills are running at high speed, the DLC coating makes the depth marks on drills clearly visible for easier practical use.
- The DLC coating has excellent wear and corrosion resistance.
- The DLC coating reduces friction, resulting in minimal heating of the bone during implant osteotomy.

The steps for a correct osteotomy:

1. Choose the correct implant length
2. Analyze the bone type: if it is soft, medium or dense
3. Follow the indication of the drilling sequence, according to the bone type and implant chosen
4. Check the length of the twist drills on the bottom right-hand corner of the surgical kit

Note: To place the JD Implant Ø6.0, it is necessary to buy separately the appropriate surgical drill Ø4.8 not present in the standard Kit version

Implant drivers:

On the left of the JD Surgical Kit two implant drivers, one short and one long, are included. We will provide you with the driver compatible driver according to the chosen implant line.

Important: To simplify the final prosthetic rehabilitation, at the time of the final placement of the implant, when the desired depth has been reached, it is necessary to align the side of the hexagon and not the vertex in the implant driver with the vestibular side. In this way, the hexagonal shape of the internal connection makes it possible to position and orient the prosthetic abutment in an optimal manner.



Prosthetic Screwdrivers:

The JD Surgical Kit includes also two screwdrivers for the prosthetic screws, the cover screws, impression copings screws. These screwdrivers are designed to be used both manually and with JDTorque torque wrench. We will provide you with the prosthetic screwdriver according to the chosen implant line.



Surgical Adaptor:

The surgical adaptor is used with the appropriate implant driver for a manually implant insertion. When it is not possible to go ahead manually with implant insertion, insert the adaptor into the JDTorque device to screw the implant into its final position.



JDTorque:

JDTorque is the manual torque wrench manufactured by JDentalCare. It enables you to manually insert, tighten and/or loosen JDentalCare implants, abutments and prosthetic screws, achieving a specific value of torque. Tightening torques range from 10 to 80 Ncm.



Direction indicators:

The kit includes two direction indicators, one short 10mm length and one long 15mm length. These tools shall be used after the drill Ø 2.0mm. These instruments have also marks to measure the depth of the implant site.



Drill stop:

This devices are used with the drill to limit the drilling depth to a predefined value, during the preparation of the implant site.



JD BONE TRACK™ DRILLS KIT

Standard Kits

Surgical Kits

Product Code: JDBTK

Place implants in post extractive sites correctly and accurately with JD Bone Track drills!

The JD Bone Track drill is a registered product, specifically designed to simplify the insertion of the post-extractive implant. JD Bone Track drills are characterized by a diamond cutting body and a non-cutting tip. Follow the Bone Track method!



The JD Bone Track drills are specifically designed to simplify the immediate insertion of the post-extractive implant.

JD Bone Track drills are characterized by a diamond cutting body and a non-cutting tip. They are available in four different implant diameters (Ø 3.2, Ø 3.7, Ø 4.3, Ø 5.0mm).



Drills for non guided protocol:

- JDDIADR32 Diamond Drill Ø 3.2
- JDDIADR37 Diamond Drill Ø 3.7
- JDDIADR43 Diamond Drill Ø 4.3
- JDDIADR50 Diamond Drill Ø 5.0



Product Code: JDODK

The JD Onedrill Kit is composed with 5 drills that allows you to simplify the drilling sequence. Use just one drill to create the implant site in case of soft or medium bone (Type III-IV), or two sequential drills in case of dense bone (Type I-II).

The drills of the JD Onedrill Kit are used to prepare the osteotomy for placement of JDEvolution and JDEvolution S implants.



The drills of JD Onedrill kit are specially designed tapered with four blades edges.

They simplify the drilling sequence, reducing the operation time and the post operative morbidity.

These drills are available for four different diameters implants (3.2, 3.7, 4.3 and 5mm) characterized by different color codes.

Drills for non guided protocol:

JDID	Initial Drill
JDOD32	Implant Drill \varnothing 3.2
JDOD37	Implant Drill \varnothing 3.7
JDOD43	Implant Drill \varnothing 4.3
JDOD50	Implant Drill \varnothing 5.0
JDDREXT	Drill Extension
JDOD32P	Direction Indicator for JDOD32
JDOD37P	Direction Indicator for JDOD37
JDOD43P	Direction Indicator for JDOD43
JDOD50P	Direction Indicator for JDOD50



Product Code: JDGSK

The JD Guided Surgery Kit is the surgical kit made by JDentalCare to support computer guided surgery.

This kit is complete, reliable and easy to use. Its strength is compatibility: with just one kit you can use all fixtures of JDentalCare implant lines, with diameters from 2.75 mm to 5.0 mm and lengths from 6 mm to 15 mm. You will also be able to purchase and complete the kit with 18, 20, 22, 24, 26mm long drills for guided pterygoid and nasal implant placement.

*The 18, 20, 22, 24, 26mm long drills are contained in the JD Guided Surgery Kit Extra Drills (Code: JDKIT02)

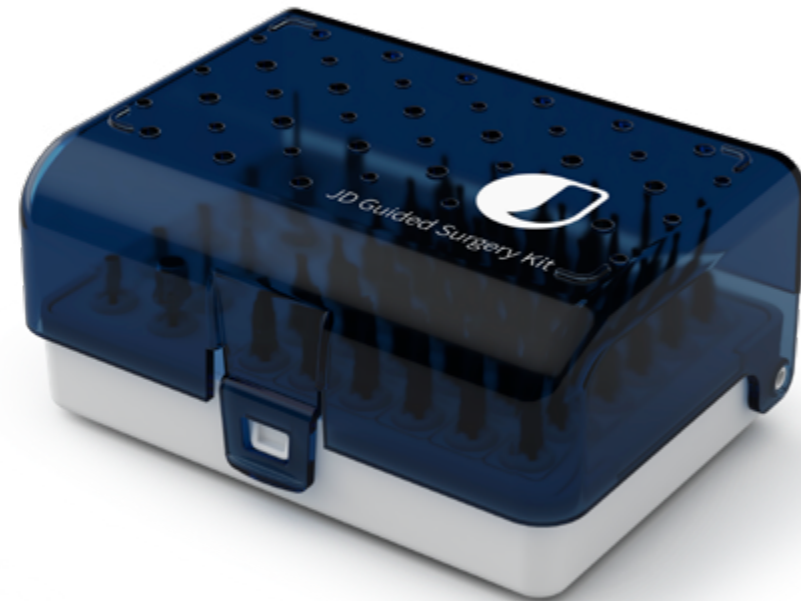
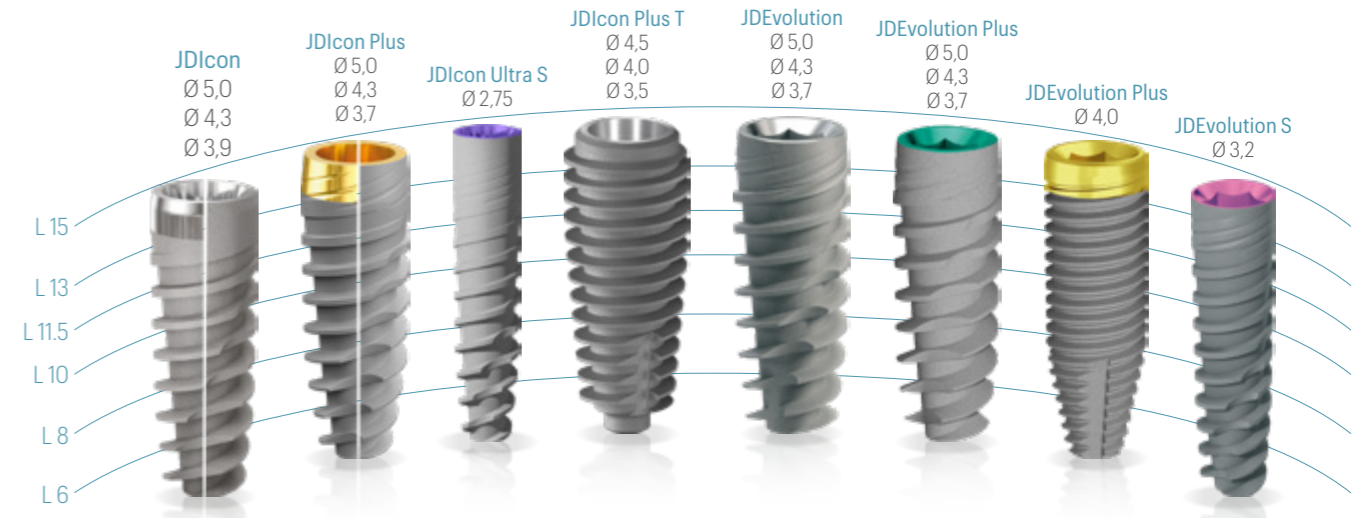

Simplicity

One kit for all JD implant lines

Simplified insertion with just one kit for all fixtures of JDentalCare implant lines, with diameters from 2.75 mm to 5.0 mm and lengths from 6 mm to 15 mm.

Let your hand be guided by the JD Guided Surgery Kit

The ideal solution to perform a minimally invasive surgery with more precision, increased predictability results and with few simple guided surgery steps.

All JD Guided Drills have a non cylindrical special design with two lateral cuts which allows:

- A less friction on the sleeves, avoiding overheating
- A better external irrigation during the implant site preparation



Compatibility

Guided implant depth control

High precision in surgical procedures: implants are placed to the planned depth using a surgical guide and the guided surgery instruments are used in combination with a single sleeve of Ø 5.01mm for a secure implant depth control.

Precision

User-friendly software design

A single kit compatible with the main Software programs for guided surgery present on the market.



INNER DIAMETERS:

Ø 5.01mm



Ø 1.53mm

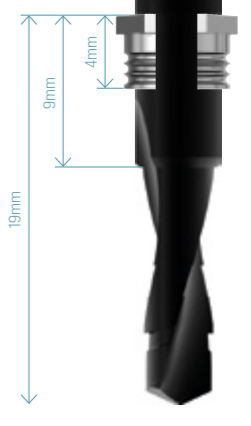

Product Code: JDKIT02

The JD Guided Surgery Extra Drills Kit is a kit that includes drills to be used for JDNasal and JDPterygo implant placement using the guided surgery technique.



Drills:

JDGD20-180	Guided Drill Ø 2.0 L 18.0
JDGD20-200	Guided Drill Ø 2.0 L 20.0
JDGD20-220	Guided Drill Ø 2.0 L 22.0
JDGD20-240	Guided Drill Ø 2.0 L 24.0
JDGD20-260	Guided Drill Ø 2.0 L 26.0
JDGD24-180	Guided Drill Ø 2.4 L 18.0
JDGD24-200	Guided Drill Ø 2.4 L 20.0
JDGD24-220	Guided Drill Ø 2.4 L 22.0
JDGD24-240	Guided Drill Ø 2.4 L 24.0
JDGD24-260	Guided Drill Ø 2.4 L 26.0



Product Code: JDKIT04

The JDPterygo Surgical Kit is specially developed by JDentalCare for implants placements in pterygoid bone. Is a complete kit and easy to use that contains inside all the necessary instruments to make the correct osteotomy and to secure positioning of JDPterygo and JDPterygo One implants.

The kit offers all the surgical and prosthetic instruments compatible with JDPterygo and JDPterygo One implants.



Drills for non guided protocol:

JDDRPT20	Drill Ø 2.0 JDPterygo
JDDRPT24	Drill Ø 2.4 JDPterygo
JDDR101	Drill Ø 2.8 JDPterygo
JDDRPT32	Drill Ø 3.2 JDPterygo



Implant and prosthetic drivers:

JDID100	JD Implant Driver - JDPterygo	JDPterygo
EVSDPF60:	Prosthetic Driver for JDTorque L60 JDEvolution Plus	
JDID101	JD Implant Driver - JDPterygo One	JDPterygo One
EVSDPF60	Prosthetic Driver for JDTorque L 60	



JDPterygo Drills Kit

Maxilla-For-All® Kits

Surgical Kits

Product Code: JDKIT01

The JDPterygo Drills Kit contains drills specifically designed for the insertion of JDPterygo and JDPterygo One implants into the pterygoid bone. The kit contains longer drills for proper bone preparation in the apical and coronal areas. These drills allow a precise, safe and fast osteotomy.



Drills:

JDDRPT20	Drill Ø 2.0 JDPterygo
JDDRPT24	Drill Ø 2.4 JDPterygo
JDDR101	Drill Ø 2.8 JDPterygo
JDDRPT32	Drill Ø 3.2 JDPterygo

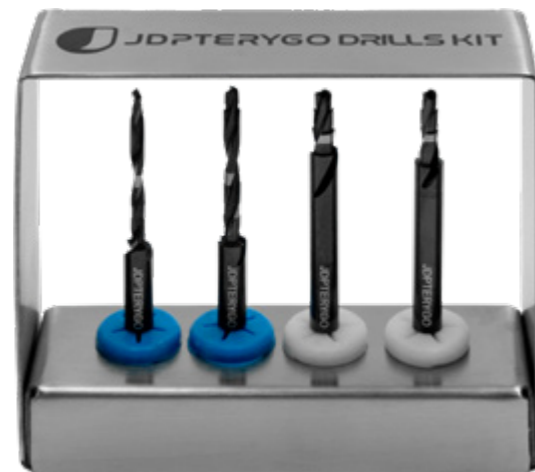

JDNasal Kit

Maxilla-For-All® Kits

Surgical Kits

Product Codes: JDNAK / JDNAKF

The JDNasal Kit includes drills specifically designed for the insertion of JDNasal implants. These drills allow precise and fast osteotomy.

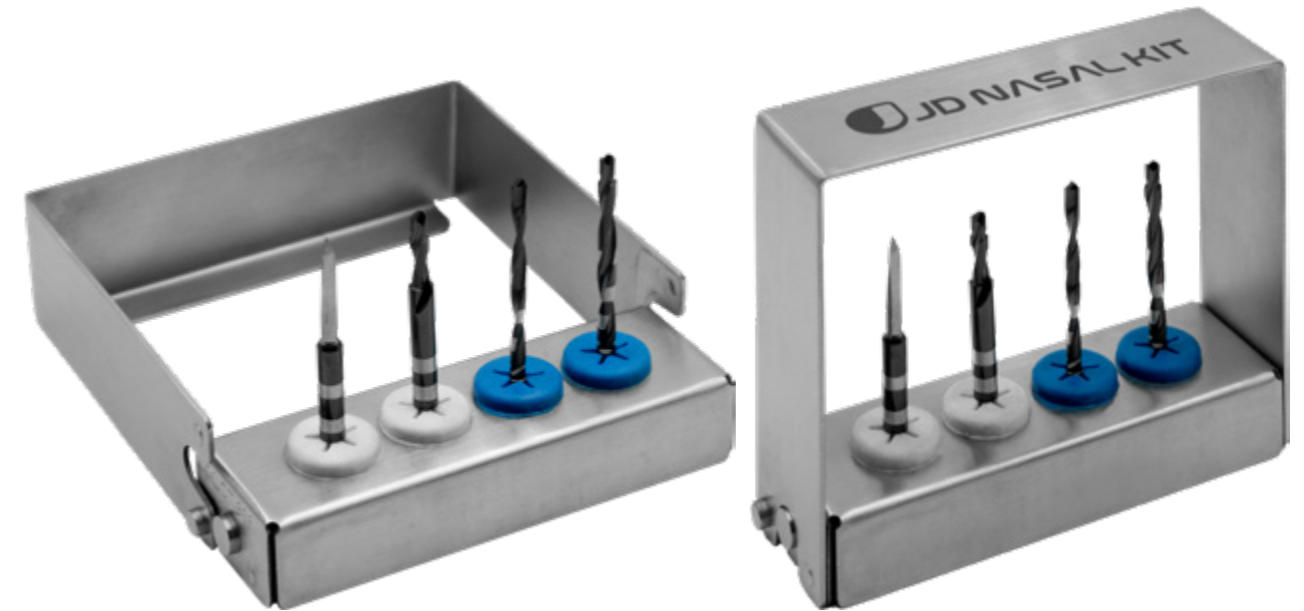

Drills:

JDIDNA*	Initial Drill JDNasal
JDDR20L	Drill Ø 2.0 JDNasal
JDDR24L	Drill Ø 2.4 JDNasal
JDDRNA24*	Helix Drill Ø 2.4 JDNasal

*JDNAK is composed only by these two drills.



Product Code: ZSKITE - ZSKITF

The JDZygoma Kit is a complete and easy-to-use surgical kit for implant placement in the zygomatic bone. The kit contains all the necessary instruments for JDZygoma and JDZygoma One implant placement.

The JDZygoma Kit is available in two versions: choose the one that best suits your needs.



JDZygoma Kit Extra
Code: ZSKITE

Drills for non guided protocol:

JDDRZSF28	Round Bur Drill Ø 2.8 JDZygoma
ZJDDREXS150NP	Initial Drill L 50 new profile JDZygoma
ZJDDREXS170NP	Initial Drill L 70 new profile JDZygoma
JDDIADR	Diamond Drill JDZygoma
JDDIADR L	Diamond Drill Long JDZygoma
ZJDDREXS150N	Zygomatic Drill 1 L 50 - 3 Flutes
ZJDDREXS170N	Zygomatic Drill 1 L 70 - 3 Flutes
ZJDDREXS250N	Zygomatic Drill 2 L 50 - 3 Flutes
ZJDDREXS270N	Zygomatic Drill 2 L 70 - 3 Flutes
ZJDDREXS350N	Zygomatic Drill 3 L 50 - 3 Flutes
ZJDDREXS370N	Zygomatic Drill 3 L 70 - 3 Flutes
JDZPR	60mm Depth Probe JDZygoma



Implant and prosthetic drivers:

EVID:	Implant Driver JDEvolution Plus
EVSUDMAX	Surgical Driver Max JDEvolution

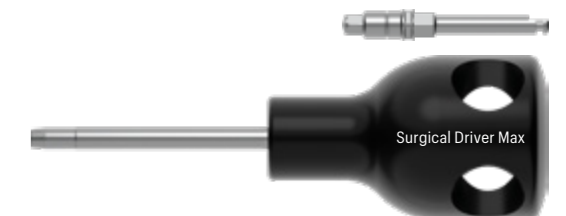



JDZygoma Kit Full
Code: ZSKITF

This kit has the same products as the JDZygoma Kit Extra, with the addition of the following instruments:

Drills for non guided protocol:

ZJDDRID50	Initial Drill L 50 JDZygoma
ZJDDR28	Drill Ø 2.8 JDZygoma
ZJDDR28L	Long Drill Ø 2.8 JDZygoma
ZJDDR32	Drill Ø 3.2 JDZygoma
ZJDDR32L	Long Drill Ø 3.2 JDZygoma
ZJDDR36	Drill Ø 3.6 JDZygoma
ZJDDR36L	Long Drill Ø 3.6 JDZygoma

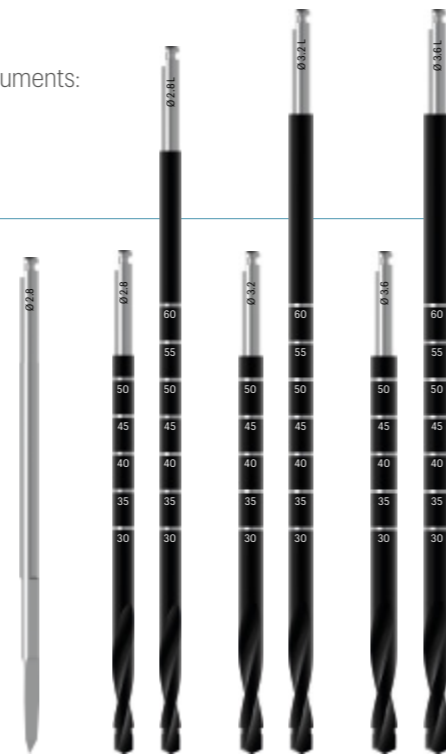

SURGICAL INSTRUMENTS

JDGuide	34
JDTorque	36
Bone Mill	37
Tissue Punch	37
Surgical Drivers	38
Direction Indicators	38
Aligning Instruments	39
Depth Probes	39
JD Removal and Repair Tools	40
JDWeld	42

Product Code: JDG

The JDGuide is a device that ensures correct implant placement with the Full Arch on 4 technique: an easy, fast and accurate support to make implant placement increasingly safe for full arch rehabilitation. The guide consists of a titanium band that can be moulded to the shape of the arch. The lines on the guide allow to identify the correct inclination for implant insertion and prosthesis design to perform a more accurate osteotomy.

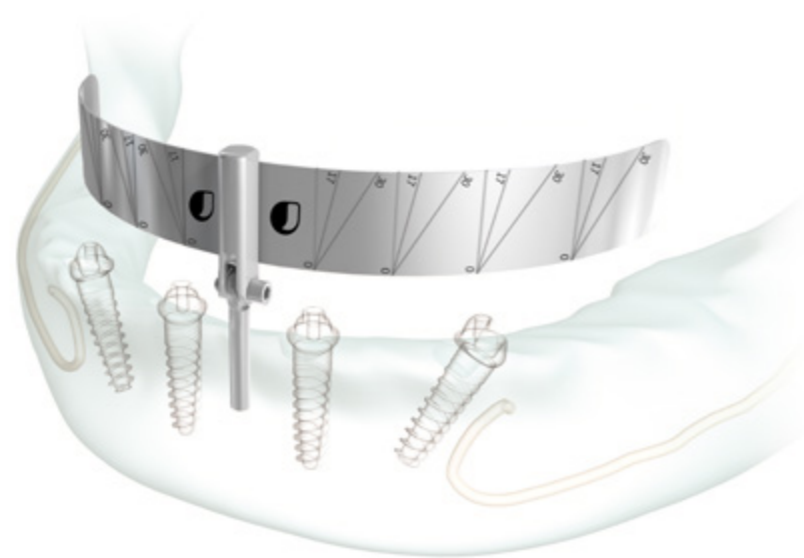

The Guide is a surgical guide that assists the dentist in the placement of four implants to support an immediately-loaded fixed full-arch implant prostheses.

Today, thanks to the innovative techniques of modern implantology, only four dental implants are needed to rehabilitate an entire dental arch of edentulous patients or subjects with terminal dentition. In these cases, two implants are placed vertically in the anterior region and the other two implants are placed in the posterior region at a maximum inclination of 30°. In cases of severe atrophy of the maxilla or mandible, tilted implants are a viable alternative to bone grafting.

Edentulous patients or patients with a terminal dentition can be treated with a fixed prosthesis supported by only four implants, two placed vertically in the anterior region and two placed up to an angle of 30° in the posterior region.

When used in the mandible tilting of posterior implant makes it possible to achieve good bone anchorage without interfering with mental foramina. In severely resorbed maxilla, tilted implants are in alternative to sinus floor augmentation.

The JDGuide is placed in a 2mm osteotomy that is made in the midline position of the maxilla or mandible.

The Guide also assists in retracting the tongue in mandibular cases. The lines on the Guide are used as a reference for placing parallel anterior implants and angled posterior implants, guiding the drill for proper insertion. The maximum inclination indicated on the guide for implant insertion is 30°.

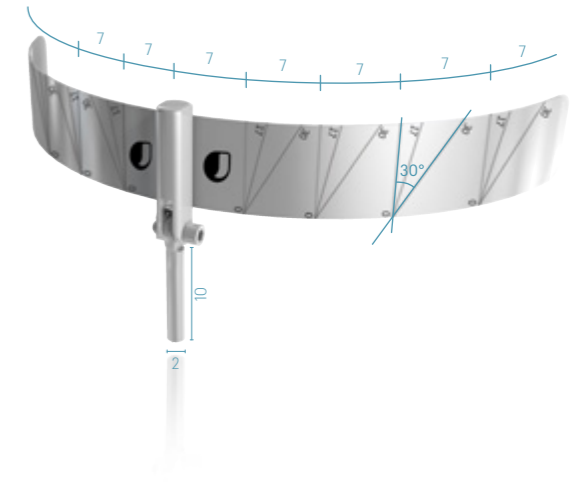

Clinical procedures for mandible

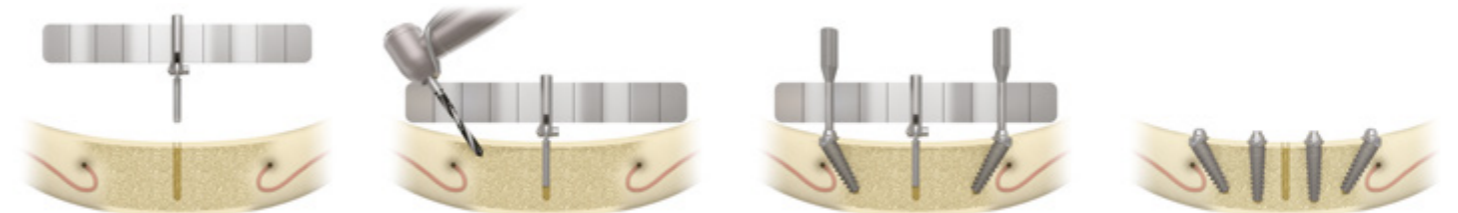

1. Insert the JDGuide
After making an incision for flap elevation drill to a depth of 10 mm using a Ø 2mm drill. Place the JDGuide in the osteotomy.

2. Prepare the posterior site
Drill to appropriate depth using a Ø 2mm drill tilted to a maximum angle of 30°. It is important to identify the mental foramen. The final position of the implant should be in front of the foramen, avoiding the nerve loop.

Note: If indicated, use the Bone Mill with Bone Mill Guide to remove bone that may obstruct correct seating of the abutment. Place 30° conical abutment. Perform the same procedure at the opposite posterior site.

3. Prepare the anterior site
Drill to the appropriate depth with a Ø 2mm drill in the anterior region following the vertical lines of the JDGuide. Insert two parallel implants into the two anterior sites. If indicated, use the Bone Mill with Bone Mill Guide to remove bone that may obstruct correct seating of the abutment. Place straight conical abutment.

Clinical procedures for maxilla



To perform treatment in the maxilla, perform the same operations as indicated above for the preparation of implant sites in the mandible for both posterior and anterior areas. Before starting treatment, it is important to first identify the anterior sinus wall.

For the posterior region preparation of the site, start the preparation in the furthest area, keeping approximately 4mm away from the sinus wall. For preparation of tilted sites in posterior and anterior regions, incline the drill as much as possible, never exceeding 30°, to minimise the overhang.

Product Code: JDTW

The device JDTorque is the manual torque wrench manufactured by JDentalCare, used to manually tighten and/or loosen JDentalCare implants, abutments, achieving a specific value of torque. It is able to measure the torque up to 80 Ncm. Design, functionality, practicality and low weight make this tool easy to use in daily practice.



Product features:

- Torque measurement from 15 to 80 Ncm
- Adaptable to all JDentalCare implants and prosthetic components by using the Prosthetic Adapter and the Surgical Adapter for JDTorque.
- It can be used both as a dynamometric and fixed key
- The device is reusable. It can be subjected to sterilization in autoclaves with temperatures up to 134°C without altering its characteristics. For a correct efficiency of surgical instruments, we recommend a maximum of 20-30 uses.
- No assembly is required saving time even during care and maintenance operations

Torque wrench and adapters:

JDTW	Torque Wrench JDTorque
JDTWA	Surgical Adapter for JDTorque
JDTWAP	Prosthetic Adapter for JDTorque



The Bone Mill is used when the implant is inserted few millimeters under the bone crest and therefore there is difficulty inserting the abutment. The aim of the bone mills is to remove the excess bone without uncover the implant that will stay totally in the bone.

Bone mills:

JDBMNNC	Bone Mill Ø 5.0 and Guide JDEvolution
JDBM6NC	Bone Mill Ø 6.0 and Guide JDEvolution
JDBMGNN	Bone Mill Guide JDEvolution
JDBMNNC:	Bone Mill Ø 5.0 and Guide JDEvolution Plus
JDBM6NC:	Bone Mill Ø 6.0 and Guide JDEvolution Plus
JDBMGNN:	Bone Mill Guide JDEvolution Plus
ESBM5C	Bone Mill Ø 5.0 and Guide JDEvolution S
ESBM6C	Bone Mill Ø 6.0 and Guide JDEvolution S
JDBM3	Bone Mill Guide JDEvolution S
ICBM5C.	Bone Mill Ø 5.0 and Guide JDIcon Plus
ICBM6C.	Bone Mill Ø 6.0 and Guide JDIcon Plus
ICBMG.	Bone Mill Guide JDIcon Plus



TISSUE PUNCH

The Tissue Punch is used to punch out the soft tissue in the osteotomy where the implants will be placed. It is intended to be used for the flapless technique.

Tissue punch

JDTP30	Tissue Punch Ø 3.0
JDTP35	Tissue Punch Ø 3.5
JDTP42	Tissue Punch Ø 4.2
JDTP50	Tissue Punch Ø 5.0
JDTPG30	Tissue Punch Guide Ø 3.0
JDTPG35	Tissue Punch Guide Ø 3.5
JDTPG42	Tissue Punch Guide Ø 4.2
JDTPG50	Tissue Punch Guide Ø 5.0



SURGICAL DRIVERS

Products Code: EVSUD - EVSUMAX

The EVSUD Surgical Driver is used for manual insertion of JDentalCare implants in the jaw or mandible during dental implant surgery. It is characterized by hexagonal connection compatible with all implant drivers JDentalCare.

The stem is made of stainless steel and the handle is black anodised.



The EVSUDMAX surgical driver max differs from the EVSUD surgical driver in handle design. The handle is larger and designed to allow easier use by the clinician when inserting zygomatic implants.



DIRECTION INDICATORS

It is possible to check the orientation or the depth of the implant site while drilling at any time using the direction indicator. An X-ray examination may be necessary to verify parallelism with other adjacent teeth or implants. They are useful in case it is also necessary to correct the direction of drilling.

Direction indicators:

JDDI	Direction Indicator
JDDIS	Direction Indicator Short
JDDI17	Direction Indicator 17°
JDDI30	Direction Indicator 30°
JDDI45	Direction Indicator 45°
JDOD32P	Direction Indicator for JDOD32
JDOD37P	Direction Indicator for JDOD37
JDOD43P	Direction Indicator for JDOD43
JDOD50P	Direction Indicator for JDOD50



ALIGNING INSTRUMENTS

Reduce the time on choosing the required abutment:

1. Position the newly inserted implant instrument
2. Measure and choose the correct abutment with the right angulation (17°, 30°, 35°)

Conical abutments aligning instruments:

EVAMT	Conical Abutment Aligning Instrument JDEvolution
ESAMT	Conical Abutment Aligning Instrument JDEvolution S
JDID102	ZAPA Tool
JDID105	Conical Abutment Aligning Instrument JDIcon PLus

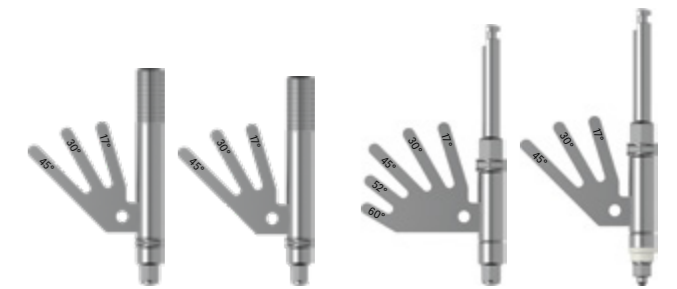

DEPTH PROBES

These JD Depth Probes are designed to help you checking the depth of the osteotomy, following you step by step. It helps you finding the correct implant length.

Depth probes:

JDNPR	26 mm Depth Probe JDNasal
JDSPR	Dental Implant Depth Probe
JDZPR	60mm Depth Probe JDZygoma



JD Removal and Repair Tools include implant removal tools, screw removal tools and internal thread repair tools.

The EVIRT is the JDentalCare tool developed to remove implants with internal and external connection.

The screw removal tools consists of EVCD, EVEX1 and EVEX2 and can be used to remove a broken screw from the implant with internal hex connection.



JD implant removal tool

The implant removal tool EVIRT can be used to remove implants in case of peri-implantitis or when the implant's connection is damaged and the ordinary implant driver cannot be used to extract it.

The EVIRT implant removal tool shall be used by placing the JD Torque in "out" position to start performing counter-clockwise rotations.

The EVIRT implant removal tool has an external hexagon that should be combined with the surgical adapter JDTWA.



JD screw removal tools

The screw removal tools can be used to remove a broken screw from an implant with an internal hexagonal connection.

Such tools can be used when the prosthetic screw connecting the abutment to the fixture is damaged and cannot be removed with the prosthetic screwdriver.

It is possible to remove a broken screw from an implant if it has not been damaged during a previous removal attempt.

Insert the EVCD Centering device JDEvolution into the implant and try to engage the broken screw with the EVEX1 claw drill mounted on the JDTWAPM manual prosthetic adapter, exerting constant pressure and rotating counter-clockwise.

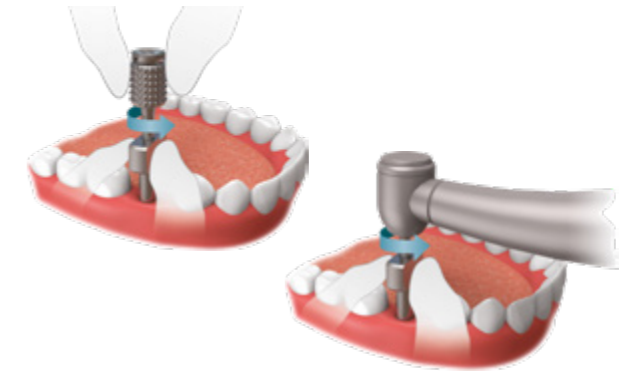

In case the broken screw is locked, place the EVEX1 Claw Drill into the handpiece. Set the handpiece rotation counter-clockwise without ever exceeding the maximum speed of 600 rpm and insist on the broken screw to flatten it. Remove the EVEX1 Claw drill from the handpiece and insert the EVEX2 Reverse cutting drill in its place. Set the rotation of the program counter-clockwise without ever exceeding the maximum speed of 600 rpm. During this operation proceed with plenty of water irrigation.

Place the EVEX2 Reverse cutting drill in the EVCD centering device, start the spindle rotation, hold it for no more than 3 seconds on the broken screw and release it. This will result in the progressive destruction of the broken vine. It is absolutely necessary that the EVCD centering device remains stationary in its position during the entire operation, as if the EVCD moves, the EVEX2 may be subject to breakage. Once the screw is destroyed, any fragment or residue can be removed from the cavity with air, water and/or suction.

JD internal thread repair tool

The EVTR Internal Thread Repair tool can be used to repair the internal thread of the system in case it is damaged. It can be used with JDEvolution implants.

The instrument must be mounted in the JDTWAPM manual prosthetic adapter and, after being inserted into the implant to be repaired, it is necessary to proceed with gentle movements rotating clockwise. This instrument is to be used only manually, therefore without recourse to handpiece or contra-angle.

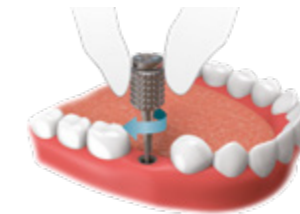

Removal and repair tools:

EVIRT	Implant removal tool
EVCD	Centering device JDEvolution
EVEX1	Claw drill
EVEX2	Reverse cutting drill
EVTR	Internal thread repair tool JDEvolution



Product Code: JDW

JDWeld makes it possible to create a structure by making a series of welds joining the abutments to a titanium connecting bar, thus providing a stable structure for temporary or permanent restorations with immediate or delayed loading.



The JDWeld works by performing resistance spot welding

The JDWeld makes it possible to create a framework from a series of welds which join abutments to a connecting titanium bar. The electric power is concentrated on the contact points between the titanium wire and the abutment, leading to the fusion of the titanium at that point in order to allow the formation of the weld in a very short time (in the order of milliseconds). When used at implant level, these frameworks support extremely reliable temporary restorations, and rigidly stabilize immediately loaded implants, resulting in a dramatic improvement in implant success rates. When used at abutment level, intra oral welding makes it possible to manufacture extremely high quality and durable prosthetics with enormous precision.

This quick and simple procedure is completely risk free for both surgeon and patient. There is absolutely no possibility of excessive heat and the procedure causes no discomfort of any sort to the patient.

After the intra oral welding, it is possible to make extremely precise abutment impression, thanks to the solid connections between abutments which give immediate stability and precision.



Compulsory guidelines

- Use only JDWeld unit and dedicated components and bars
- Inter-abutment distance: less than 8mm, use 1.5mm bar more than 8mm & less than 15mm, use 2mm bar
- Cantilever: less than 14mm from abutment centre, weld a double bar (2mm wire) + vertical spur
- Do not segment the main bar - use a single piece of wire
- Correct clamp positioning: tip base parallel to the bar
- During welding, completely release the clamp (do not open)

Temporary restorations on implant level

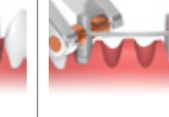
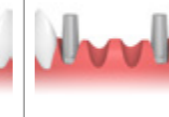
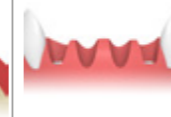
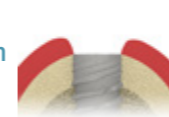

Temporary or durable restorations on abutment level

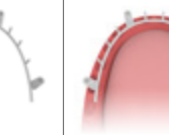
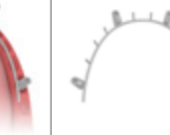
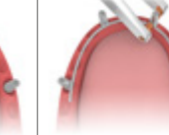
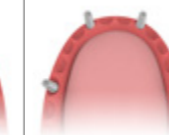

1. Placement of implants

2. Placement of dedicated welding abutments

3. Bending, alignment and intraoral welding of titanium wire

4. Extraorally welded retentions are added to the framework

5. Finalized and opaque coated titanium framework

6. Finished restoration

Features

- **Safety functions:** automatic detection of open or disconnected clamps, control of weld sequence, galvanic isolation from the mains.
- **Multi-language user menu**
- **Visual indicator and acoustic signal of welding:** steps and operations required to minimise fabric heating.

- **Minimum waiting time between consecutive welds.** Improvement of the success rate of implants inserted with low primary stability.
- **Wide power adjustment range and customisable settings**

JDWeld and JDWeld Bars:

JDW	Intraoral Welding JD Weld
JDW12	JDWeld Bar Ø 1.2
JDW15	JDWeld Bar Ø 1.5
JDW20	JDWeld Bar Ø 2.0



GP Abutments:

EVGPA40NEC	GP Abutment Ø 4.0 Non Engaging JDEvolution
EVGPA50NEC	GP Abutment Ø 5.0 Non Engaging JDEvolution
EVGPA40NEC:	GP Abutment Non Engaging Ø 4.0 JDEvolution Plus
EVGPA50NEC:	GP Abutment Non Engaging Ø 5.0 JDEvolution Plus

Torque recommended 30 Ncm



Conical Abutments:

EVCATANEWC	Temporary Abutment Non Engaging Conical Abutment for Welding JDEvolution
EVCATANEWC:	Temporary Abutment Non Engaging Conical Abutment for Welding JDEvolution Plus
EVCATANEWSC	Temporary Abutment Non Engaging Conical Abutment Smooth for Welding JDEvolution
EVCATANEWSC:	Temporary Abutment Non Engaging Conical Abutment Smooth for Welding JDEvolution Plus
EVCAGPANEWC	GP Abutment Non Engaging for Conical Abutment JDEvolution
EVCAGPANEWC:	GP Abutment Non Engaging for Conical Abutment JDEvolution Plus

Torque recommended 30 Ncm





Torque recommended 15 Ncm



DRILLING PROTOCOLS

Non Guided Surgery	46
Guided Surgery	54



JDEvolution, JDEvolution Plus

IMPLANT DIAMETER	HEALED BONE		POST EXTRACTIVE BONE		
	SOFT BONE	MEDIUM-DENSE BONE	SOFT BONE	MEDIUM-DENSE BONE	
Site preparation in maxilla					
Ø 3,7	2,0 2,4 2,8 up to the 1 st laser mark L 6mm	2,0 2,4 2,8 3,2 up to the 1 st laser mark L 6mm	2,0 2,4 2,8 at the entrance	2,0 2,4 2,8 at the entrance	 Short Implant L 6mm JDEvolution Plus insertion in maxilla short Ø 4,0 L 6 - Start the osteotomy with standard twist drill Ø 2,0mm and Ø 2,4mm - Complete with the Ø 4mm L 6mm drill code JDDICS4 short Ø 4,3 L 6 - Start the osteotomy with standard twist drill Ø 2,0mm and Ø 2,4mm - Complete with the Ø 4mm L 6mm drill code JDDICS4 short Ø 5,0 L 6 - Start the osteotomy with standard twist drill Ø 2,0mm and Ø 2,4mm - Complete with the Ø 4mm L 6mm drill code JDDICS4D
Ø 4,0	2,0 2,4 2,8	2,0 2,4 2,8 3,2 up to the 2 nd laser mark L 8mm	2,0 2,4 2,8 up to the 2 nd laser mark L 8mm	2,0 2,4 2,8	
Ø 4,3	2,0 2,4 2,8 3,2 at the entrance	2,0 2,4 2,8 3,2 up to the 1 st laser mark L 6-8mm 3,6 at the entrance	2,0 2,4 2,8 3,2 at the entrance	2,0 2,4 2,8 3,2 at the entrance	
Ø 5,0	2,0 2,4 2,8 3,2 3,6 up to the 1 st laser mark L 6mm	2,0 2,4 2,8 3,2 3,6 up to the 1 st laser mark L 6mm 4,0 at the entrance	2,0 2,4 2,8 3,2 3,6 at the entrance up to the 1 st laser mark L 6mm	2,0 2,4 2,8 3,2 3,6 at the entrance up to the 1 st laser mark L 6mm	
Ø 6,0	2,0 2,4 2,8 3,2 3,6	2,0 2,4 2,8 3,2 3,6 4,0 4,4 up to the 1 st laser mark L 6mm	2,0 2,4 2,8 3,2 3,6 4,0	2,0 2,4 2,8 3,2 3,6 4,0	
Site preparation in mandible					
Ø 3,7	2,0 2,4 2,8 3,2 up to the 2 nd laser mark L 8mm 3,6 up to the 1 st laser mark L 6mm	2,0 2,4 2,8 3,2 3,6 up to the 1 st laser mark L 6mm	2,0 2,4 2,8 3,2 at the entrance	2,0 2,4 2,8 3,2 at the entrance	 Short Implant L 6mm JDEvolution Plus insertion in mandible short Ø 4,0 L 6 - Start the osteotomy with standard twist drill Ø 2,0mm, Ø 2,4mm and Ø 2,8mm - Complete with the Ø 4mm L 6mm drill code JDDICS4D short Ø 4,3 L 6 - Start the osteotomy with standard twist drill Ø 2,0mm, Ø 2,4mm and Ø 2,8mm. - Complete with the Ø 4mm L 6mm drill code JDDICS4D short Ø 5,0 L 6 - Start the osteotomy with standard twist drill Ø 2,0mm, Ø 2,4mm and Ø 2,8mm. - Complete with the Ø 5mm L 6mm drill code JDDICS5
Ø 4,0	2,0 2,4 2,8 3,2 up to the 2 nd laser mark L 8mm 3,6 up to the 2 nd laser mark L 8mm	2,0 2,4 2,8 3,2 3,6 4,0 up to the 1 st laser mark L 6mm	2,0 2,4 2,8 3,2 up to the 2 nd laser mark L 8mm 3,6 up to the 1 st laser mark L 8mm	2,0 2,4 2,8 3,2 3,6 up to the 1 st laser mark L 8mm	
Ø 4,3	2,0 2,4 2,8 3,2 3,6 up to the 2 nd laser mark L 8mm 4,0 up to the 2 nd laser mark L 8mm	2,0 2,4 2,8 3,2 3,6 4,0 up to the 2 nd laser mark L 8mm 4,4 up to the 1 st laser mark L 6mm	2,0 2,4 2,8 3,2 3,6 at the entrance	2,0 2,4 2,8 3,2 3,6 at the entrance	
Ø 5,0	2,0 2,4 2,8 3,2 3,6 4,0 4,4 up to the 2 nd laser mark L 8mm 4,8 at the entrance	2,0 2,4 2,8 3,2 3,6 4,0 4,4 4,8 at the entrance	2,0 2,4 2,8 3,2 3,6 4,0 at the entrance	2,0 2,4 2,8 3,2 3,6 4,0 at the entrance	
Ø 6,0	2,0 2,4 2,8 3,2 3,6 4,0 4,4 up to the 2 nd laser mark L 8mm 4,8 up to the 2 nd laser mark L 8mm	2,0 2,4 2,8 3,2 3,6 4,0 4,4 4,8 up to the 2 nd laser mark L 8mm	2,0 2,4 2,8 3,2 3,6 4,0 4,4	2,0 2,4 2,8 3,2 3,6 4,0 4,4	

JDEvolution S

IMPLANT DIAMETER	SOFT BONE TYPE IV	MEDIUM BONE TYPE II-III	DENSE BONE TYPE I
Ø 3,2	1,5 (2)	2,0 2,4	2,0 2,4 (2,8)

JDIcon, JDIcon Plus

IMPLANT DIAMETER	HEALED BONE		POST EXTRACTIVE BONE		
	SOFT BONE	MEDIUM-DENSE BONE	SOFT BONE	MEDIUM-DENSE BONE	
Site preparation in maxilla					
Ø 3,9	2,0 2,4 2,8 up to the 1 st laser mark L 6mm	2,0 2,4 2,8 3,2 up to the 1 st laser mark L 6mm	2,0 2,4 2,8 at the entrance	2,0 2,4 2,8 at the entrance	 Short Implant L 6mm JDIcon insertion in maxilla short Ø 4,3 L 6 Use the Ø 4mm L 6 JDIcon Plus+ drill JDDICS4 short Ø 5,0 L 6 Use the Ø 4mm L 6 JDIcon Plus+ drill JDDICS4D
Ø 4,3	2,0 2,4 2,8 3,2 at the entrance	2,0 2,4 2,8 3,2 up to the 1 st laser mark L 6-8mm 3,6 at the entrance	2,0 2,4 2,8 3,2 at the entrance	2,0 2,4 2,8 3,2 at the entrance	
Ø 5,0	2,0 2,4 2,8 3,2 3,6 up to the 1 st laser mark L 6mm	2,0 2,4 2,8 3,2 3,6 up to the 1 st laser mark L 6mm 4,0 at the entrance	2,0 2,4 2,8 3,2 3,6 at the entrance up to the 1 st laser mark L 6mm	2,0 2,4 2,8 3,2 3,6 at the entrance up to the 1 st laser mark L 6mm	
Site preparation in mandible					
Ø 3,9	2,0 2,4 2,8 3,2 up to the 2 nd laser mark L 8mm 3,6 up to the 1 st laser mark L 6mm	2,0 2,4 2,8 3,2 3,6 up to the 1 st laser mark L 6mm	2,0 2,4 2,8 3,2 at the entrance	2,0 2,4 2,8 3,2 at the entrance	 Short Implant L 6mm JDIcon insertion in mandible short Ø 4,3 L 6 Start the osteotomy with standard twist drill Ø 2,0mm, Ø 2,4mm and Ø 2,8mm. Complete with the Ø 4mm L 6 JDIcon Plus+ drill JDDICS4D short Ø 5,0 L 6 Start the osteotomy with standard twist drill Ø 2,0mm, Ø 2,4mm and Ø 2,8mm. Complete with the Ø 5mm L 6 JDIcon Plus+ drill JDDICS5
Ø 4,3	2,0 2,4 2,8 3,2 3,6 up to the 2 nd laser mark L 8mm 4,0 up to the 2 nd laser mark L 8mm	2,0 2,4 2,8 3,2 3,6 4,0 up to the 2 nd laser mark L 8mm 4,4 up to the 1 st laser mark L 6mm	2,0 2,4 2,8 3,2 3,6 at the entrance	2,0 2,4 2,8 3,2 3,6 at the entrance	
Ø 5,0	2,0 2,4 2,8 3,2 3,6 4,0 4,4 up to the 2 nd laser mark L 8mm 4,8 at the entrance	2,0 2,4 2,8 3,2 3,6 4,0 4,4 4,8 at the entrance	2,0 2,4 2,8 3,2 3,6 4,0 at the entrance	2,0 2,4 2,8 3,2 3,6 4,0 at the entrance	

JDIcon Ultra S

IMPLANT DIAMETER	SOFT BONE TYPE IV	MEDIUM BONE TYPE II-III	DENSE BONE TYPE I
Ø 2,75	1,5 2,0	2,0 2,4	2,0 2,4 2,8 up to the 1 st laser mark

JDIcon Plus T

IMPLANT DIAMETER	HEALED BONE		POST EXTRACTIVE BONE	
	SOFT BONE	MEDIUM-DENSE BONE	SOFT BONE	MEDIUM-DENSE BONE
Site preparation in maxilla				
Ø 3,5	2,0	2,0	2,0	2,0
	2,4 2,8 up to the 1 st laser mark L 6mm	2,4 2,8 3,2 up to the 1 st laser mark L 6mm	2,4 2,8 3,2 up to the 1 st laser mark L 6mm	2,4 2,8 2,8 at the entrance
Ø 4,0	2,0	2,0	2,0	2,0
	2,4 2,8 3,2 at the entrance	2,4 2,8 3,2 up to the 1 st laser mark L 6-8mm 3,6 at the entrance	2,4 2,8 3,2 at the entrance	2,4 2,8 3,2 at the entrance
Ø 4,5	2,0	2,0	2,0	2,0
	2,4 2,8 3,2 3,6 up to the 1 st laser mark L 6mm	2,4 2,8 3,2 3,6 up to the 1 st laser mark L 6mm 4,0 at the entrance	2,4 2,8 3,2 3,6 at the entrance up to the 1 st laser mark L 6mm	2,4 2,8 3,2 3,6 at the entrance up to the 1 st laser mark L 6mm
Ø 5,0	2,0	2,0	2,0	2,0
	2,4 2,8 3,2 3,6 4,0 4,8 up to the 1 st laser mark L 6mm	2,4 2,8 3,2 3,6 4,0 4,8 up to the 1 st laser mark L 6mm	2,4 2,8 3,2 3,6 4,8 at the entrance	2,4 2,8 3,2 3,6 4,0 at the entrance 4,8 up to the 1 st laser mark L 6mm
Site preparation in mandible				
Ø 3,5	2,0	2,0	2,0	2,0
	2,4 2,8 3,2 up to the 1 st laser mark L6mm	2,4 2,8 3,2 up to the 2 nd laser mark L8mm 3,6 up to the 1 st laser mark L 6mm	2,4 2,8 2,8	2,4 2,8 3,2 at the entrance
Ø 4,0	2,0	2,0	2,0	2,0
	2,4 2,8 3,2 3,6 up to the 2 nd laser mark L8mm	2,4 2,8 3,2 3,6 4,0 up to the 2 nd laser mark L8mm 4,4 up to the 1 st laser mark L 6mm	2,4 2,8 3,2 at the entrance	2,4 2,8 3,2 3,6 at the entrance
Ø 4,5	2,0	2,0	2,0	2,0
	2,4 2,8 3,2 3,6 at the entrance 4,0 at the entrance	2,4 2,8 3,2 3,6 4,0 4,4 4,8 at the entrance	2,4 2,8 3,2 3,6 at the entrance	2,4 2,8 3,2 3,6 4,0 at the entrance
Ø 5,0	2,0	2,0	2,0	2,0
	2,4 2,8 3,2 3,6 4,0 4,8 at the entrance	2,4 2,8 3,2 3,6 4,0 4,4 4,8	2,4 2,8 3,2 3,6 4,8 at the entrance	2,4 2,8 3,2 3,6 4,0 4,8 up to the 1 st laser mark L 6mm

Note: All measurements in mm

JD Bone Track

Follow the BoneTrack Method: a new approach that will simplify your daily clinical practice. Insert the non-cutting tip of the JD BoneTrack Drill into the underprepared osteotomy and push the drill palatally in order to create a track on the palatal bone. In this way, the correct space for the implant body will be created.

IMPLANT DIAMETER	PREPARATION IN MAXILLA	PREPARATION IN MANDIBLE
Ø 3,2	1,5 2,0 2,4 JD BoneTrack Drill 3.2	1,5 2,0 2,4 JD BoneTrack Drill 3.2
	1,5 2,0 2,4 JD BoneTrack Drill 3.7	1,5 2,0 2,4 JD BoneTrack Drill 3.7
Ø 4,3	1,5 2,0 2,4 2,8 JD BoneTrack Drill 4.3	1,5 2,0 2,4 2,8 3,2 JD BoneTrack Drill 4.3
	1,5 2,0 2,4 2,8 3,2 JD BoneTrack Drill 5.0	1,5 2,0 2,4 2,8 3,2 3,6 JD BoneTrack Drill 5.0



1. Identify the anatomy of the socket and start drilling towards the palatal bone.
N.B.: The last standard drill diameter to be used for under-prepare the osteotomy always corresponds to the implant tip diameter to be inserted.



2. Insert the non-cutting tip of the JD BoneTrack Drill into the osteotomy and push the drill palatally in order to create a track on the palatal bone.

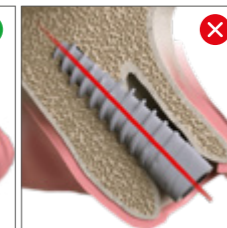
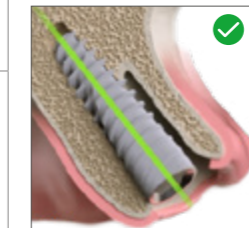

3. Insert the implant leaving the correct vestibular gap

JD Onedrill

The suggested rotation speed is 1200 - 1500 rpm and cooling is obtained by copious irrigation with physiological solution. The drills of the JD Onedrill Kit cut efficiently; reducing the downward force will allow the drill to cut without detectable chatter.

Do not pump the shaping drills as you might do with a twist drill when creating the osteotomy as it may distort the dimensions of the osteotomy. The shaping drill should be advanced once to full depth, then removed without any pumping action.

IMPLANT DIAMETER	SOFT BONE	DENSE BONE
Ø 3,2	initial drill 3,2	initial drill 3,2 3,7 until the first laser mark
	initial drill 3,2 3,7 (optional)	initial drill 3,2 3,7 4,3 until the first laser mark
Ø 4,3	initial drill 3,2 3,7 4,3 (optional)	initial drill 3,2 3,7 4,3 5,0 until the first laser mark
	initial drill 3,2 3,7 4,3 5,0 (optional)	initial drill 3,2 3,7 4,3 5,0

Important: When placing a JDEvolution implant in the bone (Type IV) the surgeon should consider undersizing the osteotomy. The final drill diameter should be limited to the one immediately smaller than the diameter that should have been used. When placing a JDEvolution implant in hard bone (Type I) do not underprepare the osteotomy site. The surgeon should consider to use as final drill diameter the one immediately bigger than the diameter that should have been used, stopping at the first laser mark. This will create an osteotomy of proper dimension in the dense cortical bone without any underpreparation.

JDPterygo

Ø 3,3

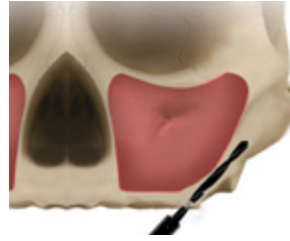

1. Start the osteotomy using JDPterygo drill Ø 2.0mm at the same implant length to be inserted



2. Complete the osteotomy with JDPterygo drill Ø 2.8mm at the entrance for 6mm

Ø 4,0

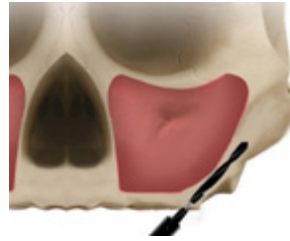

1. Start the osteotomy using JDPterygo drill Ø 2.0mm at the same implant length to be inserted.



2. Continue using JDPterygo drill Ø 2.4mm at the same implant length to be inserted.



3. Complete the osteotomy with JDPterygo drill Ø 3.2mm at the entrance for 6mm.

JDNasal: NASAL ANCHORAGE SITE PREPARATION

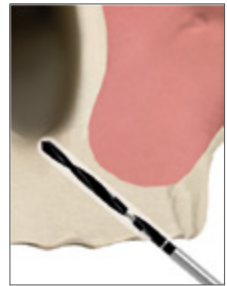

1 - JDDR20L



2 - JDNPR



3 - JDDR24L



4 - JDDR28

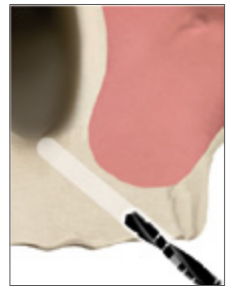

5 - JDDR32



6 - JDDR36



7 - implant

1. Initiate the site preparation with the longer Ø 2.0mm JDNasal drill through the crestal bone and reach the cortical bone of the nose.
2. Use the 26mm depth probe to verify the depth of the site, in order to support the clinician in the choice of the implant with the appropriate length.
3. Drill to final depth with the longer Ø 2.4mm JDNasal drill.
4. Continue the osteotomy with standard twist drill Ø 2.8mm at the entrance for 6mm.
5. Continue the osteotomy with standard twist drill Ø 3.2mm at the entrance for 6mm.
6. Complete the osteotomy with standard twist drill Ø 3.6mm at the entrance for 6mm.
7. Place the implant till to reach the final position. The implant shall be inserted with an insertion torque between 25 Ncm and 80 Ncm.



JDNasal: TRANS-SINUS SITE PREPARATION



1 - JDDR20



2 - JDDR24



3 - JDDR28



4 - JDDR32



5 - JDIDNA



6 - JDNPR



7 - JDDRNA24



8 - JDDR36



9A - implant



9B - implant + bone graft

1. Open a window in the lateral sinus wall and gently reflect the Schneiderian membrane without perforating it. Initiate the preparation of the implant site with standard twist drill Ø 2.0mm in order to reach and perforate the floor of the maxillary sinus. Keep the drill with a right inclination towards the canine pillar.
2. Continue with standard twist drill Ø 2.4mm till to reach and perforate the floor of the maxillary sinus.
3. Continue with standard twist drill Ø 2.8mm till to reach and perforate the floor of the maxillary sinus.
4. Continue with standard twist drill Ø 3.2mm till to reach and perforate the floor of the maxillary sinus.
5. Insert the Initial drill JDNasal into the canal created into the bone before. Drill through the alveolar process, into and across the sinus, engaging the nasal bone in correspondence with the canine pillar.
6. Use the 26mm depth probe to verify the depth of the site, in order to support the clinician in the choice of the implant with the appropriate length.
7. Use the longer Ø 2.4mm JDNasal drill to drill like the previous one through the alveolar process, into and across the sinus, engaging the nasal bone until the final depth in correspondence with the canine pillar.
8. Complete the osteotomy with standard twist drill Ø 3.6mm in the alveolar process.
- 9A. Place the implant and reach the final position without adding bone graft. The implant shall be inserted with an insertion torque between 25 Ncm and 80 Ncm.
- 9B. Optional: place the implant, reach the final position and insert bone graft into the sinus. The implant shall be inserted with an insertion torque between 25 Ncm and 80 Ncm.



Note: All measurements in mm

JDZygoma

There are two procedure to use the JDZygoma Drills:

- The first one is the **Standard Procedure**, workable with ZSKITF full kit
- The second one is the **Extra Maxillary Procedure**, workable with drill with fixed diameter "3 Flutes" present in both the kit

The peculiarity of these drills lies in the size of the diameter of the non-working course, which remains identical from the diamond drills to the drills n°3. This is because once created the recess by the diamond cutter, this will be a support for the insertion of the subsequent drill, which will adhere perfectly to the channel to be perfectly guided on the axis.

JDZygoma Ø 3.9mm

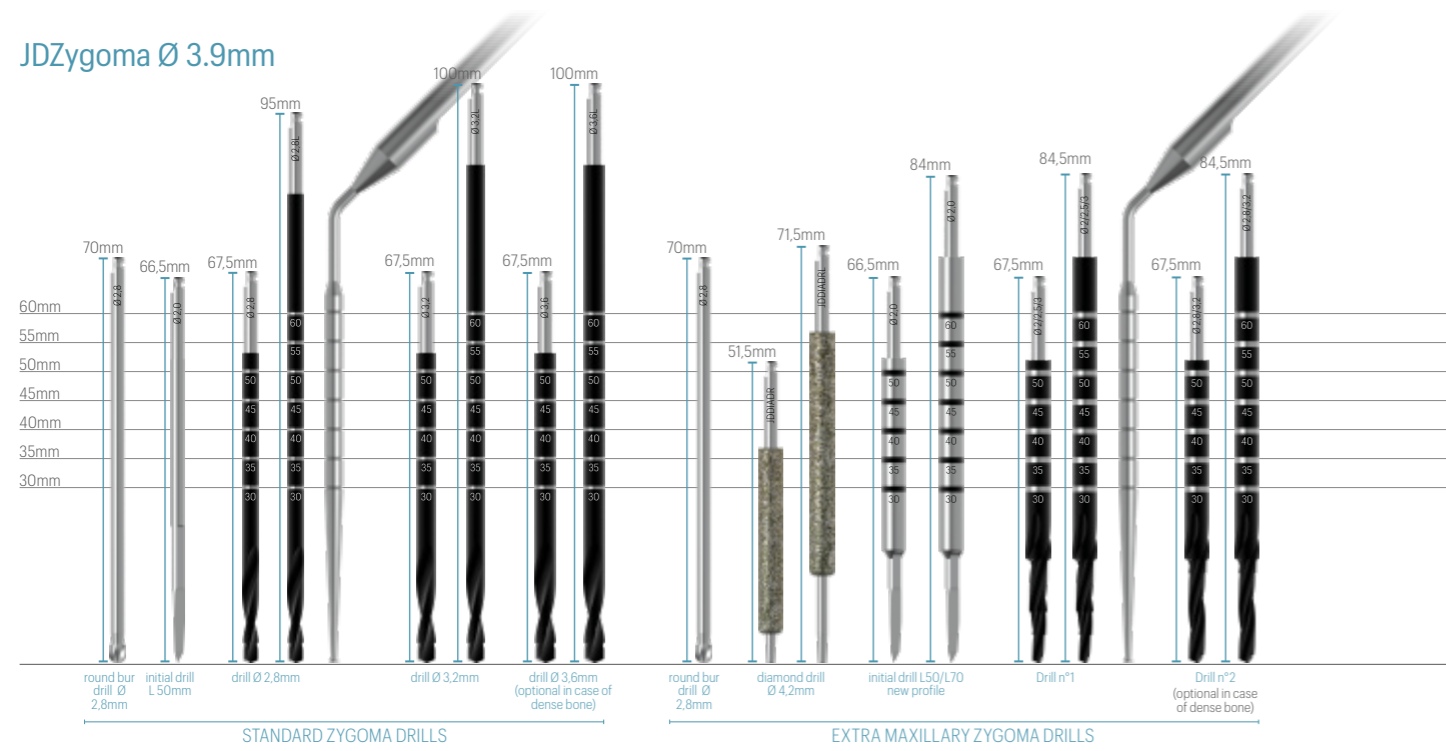

JDZygoma Ø 4.3mm

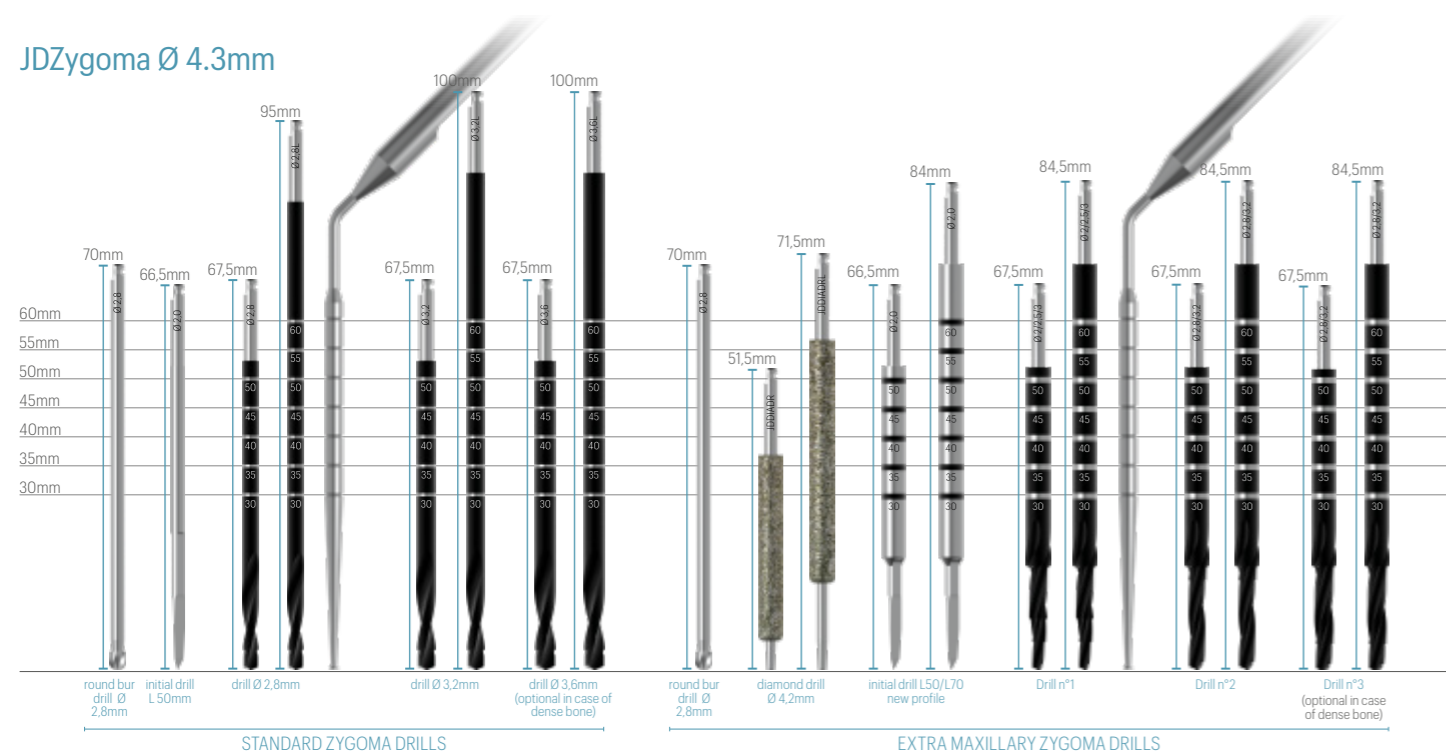

Note: All measurements in mm

The following drilling protocols are suggested to be used for the insertion of JDentalCare dental implants in case of Guided Surgery technique, using the original instruments and surgical guides manufactured by JDentalCare. It is recommended to adhere to the indications of the following drilling sequence to ensure optimal primary stability of the implant

JDEvolution, JDEvolution Plus, JDIcon, JDIcon Plus, JDIcon Plus T, JDOcta

IMPLANT DIAMETER	IMPLANT LENGTH	Site preparation in maxilla		Site preparation in mandible	
		SOFT BONE	MEDIUM-DENSE BONE	SOFT BONE	MEDIUM-DENSE BONE
Ø 3,7 / 3,9	L6	/	/	/	/
	L8	2,4 L6 - L8 2,8 L6 3,2 L6	2,4 L6 - L8 2,8 L6 3,2 L6	2,4 L6 - L8 2,8 L6 - L8 3,2 L6 3,6 L6	2,4 L6 - L8 2,8 L6 - L8 3,2 L6 3,6 L6
	L10	2,4 L6 - L8 - L10 2,8 L6 3,2 L6	2,4 L6 - L8 - L10 2,8 L6 - L8 3,2 L6	2,4 L6 - L8 - L10 2,8 L6 - L8 - L10 3,2 L6 3,6 L6	2,4 L6 - L8 - L10 2,8 L6 - L8 - L10 3,2 L6 - L8 - L10 3,6 L6
	L11,5	2,4 L6 - L8 - L10 - L11,5 2,8 L6 3,2 L6	2,4 L6 - L8 - L10 - L11,5 2,8 L6 - L8 - L10 3,2 L6 3,6 L6	2,4 L6 - L8 - L10 - L11,5 2,8 L6 - L8 - L10 - L11,5 3,2 L6 3,6 L6	2,4 L6 - L8 - L10 - L11,5 2,8 L6 - L8 - L10 - L11,5 3,2 L6 - L8 - L10 - L11,5 3,6 L6
	L13	2,4 L6 - L8 - L10 - L11,5 - L13 2,8 L6 - L8 3,2 L6	2,4 L6 - L8 - L10 - L11,5 - L13 2,8 L6 - L8 - L10 3,2 L6 - L8 3,6 L6	2,4 L6 - L8 - L10 - L11,5 - L13 2,8 L6 - L8 - L10 - L11,5 - L13 3,2 L6 3,6 L6	2,4 L6 - L8 - L10 - L11,5 - L13 2,8 L6 - L8 - L10 - L11,5 - L13 3,2 L6 - L8 - L10 - L11,5 - L13 3,6 L6
	L15	2,4 L6 - L8 - L10 - L11,5 - L13 - L15 2,8 L6 - L8 - L10 3,2 L6 - L8	2,4 L6 - L8 - L10 - L11,5 - L13 - L15 2,8 L6 - L8 - L10 - L11,5 3,2 L6 - L8 - L10 3,6 L6	2,4 L6 - L8 - L10 - L11,5 - L13 - L15 2,8 L6 - L8 - L10 - L11,5 - L13 - L15 3,2 L6 - L8 3,6 L6	2,4 L6 - L8 - L10 - L11,5 - L13 - L15 2,8 L6 - L8 - L10 - L11,5 - L13 - L15 3,2 L6 - L8 - L10 - L11,5 - L13 - L15 3,6 L6
	L18	2,4 L6 - L8 - L10 - L11,5 - L13 - L15 - L18 2,8 L6 - L8 - L10 - L11,5 - L13 3,2 L6 - L8 - L10	2,4 L6 - L8 - L10 - L11,5 - L13 - L15 - L18 2,8 L6 - L8 - L10 - L11,5 - L13 3,2 L6 - L8 - L10 - L11,5 3,6 L6	2,4 L6 - L8 - L10 - L11,5 - L13 - L15 - L18 2,8 L6 - L8 - L10 - L11,5 - L13 - L15 3,2 L6 - L8 - L10 3,6 L6	2,4 L6 - L8 - L10 - L11,5 - L13 - L15 - L18 2,8 L6 - L8 - L10 - L11,5 - L13 - L15 3,2 L6 - L8 - L10 - L11,5 - L13 - L15 3,6 L6
Ø 4,0 / 4,3	L6	2,4 L6 2,8 L6 3,2 L6	2,4 L6 2,8 L6 3,2 L6 3,6 L6	2,4 L6 2,8 L6 3,2 L6 3,6 L6	2,4 L6 2,8 L6 3,2 L6 3,6 L6 4,2 L6
	L8	2,4 L6 - L8 2,8 L6 - L8 3,2 L6 3,6 L6	2,4 L6 - L8 2,8 L6 - L8 3,2 L6 3,6 L6	2,4 L6 - L8 2,8 L6 - L8 3,2 L6 3,6 L6	2,4 L6 - L8 2,8 L6 - L8 3,2 L6 - L8 3,6 L6 - L8 4,2 L6
	L10	2,4 L6 - L8 - L10 2,8 L6 - L8 - L10 3,2 L6 3,6 L6	2,4 L6 - L8 - L10 2,8 L6 - L8 - L10 3,2 L6 - L8 3,6 L6	2,4 L6 - L8 - L10 2,8 L6 - L8 - L10 3,2 L6 - L8 3,6 L6	2,4 L6 - L8 - L10 2,8 L6 - L8 - L10 3,2 L6 - L8 - L10 3,6 L6 - L8 - L10 4,2 L6
	L11,5	2,4 L6 - L8 - L10 - L11,5 2,8 L6 - L8 - L10 - L11,5 3,2 L6 3,6 L6	2,4 L6 - L8 - L10 - L11,5 2,8 L6 - L8 - L10 - L11,5 3,2 L6 - L8 3,6 L6	2,4 L6 - L8 - L10 - L11,5 2,8 L6 - L8 - L10 - L11,5 3,2 L6 - L8 3,6 L6	2,4 L6 - L8 - L10 - L11,5 2,8 L6 - L8 - L10 - L11,5 3,2 L6 - L8 - L10 - L11,5 3,6 L6 - L8 - L10 - L11,5 4,2 L6
	L13	2,4 L6 - L8 - L10 - L11,5 - L13 2,8 L6 - L8 - L10 - L11,5 - L13 3,2 L6 - L8 3,6 L6	2,4 L6 - L8 - L10 - L11,5 - L13 2,8 L6 - L8 - L10 - L11,5 - L13 3,2 L6 - L8 3,6 L6 4,2 L6	2,4 L6 - L8 - L10 - L11,5 - L13 2,8 L6 - L8 - L10 - L11,5 - L13 3,2 L6 - L8 - L10 3,6 L6	2,4 L6 - L8 - L10 - L11,5 - L13 2,8 L6 - L8 - L10 - L11,5 - L13 3,2 L6 - L8 - L10 - L11,5 - L13 3,6 L6 - L8 - L10 - L11,5 - L13 4,2 L6
	L15	2,4 L6 - L8 - L10 - L11,5 - L13 - L15 2,8 L6 - L8 - L10 - L11,5 - L13 - L15 3,2 L6 - L8 - L10 3,6 L6	2,4 L6 - L8 - L10 - L11,5 - L13 - L15 2,8 L6 - L8 - L10 - L11,5 - L13 - L15 3,2 L6 - L8 - L10 3,6 L6 4,2 L6	2,4 L6 - L8 - L10 - L11,5 - L13 - L15 2,8 L6 - L8 - L10 - L11,5 - L13 - L15 3,2 L6 - L8 - L10 3,6 L6	2,4 L6 - L8 - L10 - L11,5 - L13 - L15 2,8 L6 - L8 - L10 - L11,5 - L13 - L15 3,2 L6 - L8 - L10 - L11,5 - L13 - L15 3,6 L6 - L8 - L10 - L11,5 - L13 - L15 4,2 L6
	L18	2,4 L6 - L8 - L10 - L11,5 - L13 - L15 - L18 2,8 L6 - L8 - L10 - L11,5 - L13 - L15 3,2 L6 - L8 - L10 3,6 L6	2,4 L6 - L8 - L10 - L11,5 - L13 - L15 - L18 2,8 L6 - L8 - L10 - L11,5 - L13 - L15 3,2 L6 - L8 - L10 - L11,5 3,6 L6 4,2 L6	2,4 L6 - L8 - L10 - L11,5 - L13 - L15 - L18 2,8 L6 - L8 - L10 - L11,5 - L13 - L15 3,2 L6 - L8 - L10 - L11,5 3,6 L6	2,4 L6 - L8 - L10 - L11,5 - L13 - L15 - L18 2,8 L6 - L8 - L10 - L11,5 - L13 - L15 3,2 L6 - L8 - L10 - L11,5 - L13 - L15 3,6 L6 - L8 - L10 - L11,5 - L13 - L15 4,2 L6

JDEvolution, JDEvolution Plus, JDIcon, JDIcon Plus, JDIcon Plus T, JDOcta

IMPLANT DIAMETER	IMPLANT LENGTH	Site preparation in maxilla		Site preparation in mandible	
		SOFT BONE	MEDIUM-DENSE BONE	SOFT BONE	MEDIUM-DENSE BONE
Ø 5,0	L6	2,4 L6 2,8 L6 3,2 L6 3,6 L6 4,2 L6	2,4 L6 2,8 L6 3,2 L6 3,6 L6 4,2 L6	2,4 L6 2,8 L6 3,2 L6 3,6 L6 4,2 L6	/
	L8	2,4 L6 - L8 2,8 L6 - L8 3,2 L6 - L8 3,6 L6 4,2 L6	2,4 L6 - L8 2,8 L6 - L8 3,2 L6 - L8 3,6 L6 4,2 L6	2,4 L6 - L8 2,8 L6 - L8 3,2 L6 - L8 3,6 L6 4,2 L6	/
	L10	2,4 L6 - L8 - L10 2,8 L6 - L8 - L10 3,2 L6 - L8 - L10 3,6 L6 4,2 L6	2,4 L6 - L8 - L10 2,8 L6 - L8 - L10 3,2 L6 - L8 - L10 3,6 L6 - L8 4,2 L6	2,4 L6 - L8 - L10 2,8 L6 - L8 - L10 3,2 L6 - L8 - L10 3,6 L6 - L8 4,2 L6	/
	L11,5	2,4 L6 - L8 - L10 - L11,5 2,8 L6 - L8 - L10 - L11,5 3,2 L6 - L8 - L10 - L11,5 3,6 L6 4,2 L6	2,4 L6 - L8 - L10 - L11,5 2,8 L6 - L8 - L10 - L11,5 3,2 L6 - L8 - L10 - L11,5 3,6 L6 - L8 - L10 4,2 L6	2,4 L6 - L8 - L10 - L11,5 2,8 L6 - L8 - L10 - L11,5 3,2 L6 - L8 - L10 - L11,5 3,6 L6 - L8 - L10 4,2 L6	/
	L13	2,4 L6 - L8 - L10 - L11,5 - L13 2,8 L6 - L8 - L10 - L11,5 - L13 3,2 L6 - L8 - L10 - L11,5 - L13 3,6 L6 - L8 4,2 L6	2,4 L6 - L8 - L10 - L11,5 - L13 2,8 L6 - L8 - L10 - L11,5 - L13 3,2 L6 - L8 - L10 - L11,5 - L13 3,6 L6 - L8 - L10 4,2 L6	2,4 L6 - L8 - L10 - L11,5 - L13 2,8 L6 - L8 - L10 - L11,5 - L13 3,2 L6 - L8 - L10 - L11,5 - L13 3,6 L6 - L8 - L10 4,2 L6	/
	L15	2,4 L6 - L8 - L10 - L11,5 - L13 - L15 2,8 L6 - L8 - L10 - L11,5 - L13 - L15 3,2 L6 - L8 - L10 - L11,5 - L13 - L15 3,6 L6 - L8 - L10 4,2 L6	2,4 L6 - L8 - L10 - L11,5 - L13 - L15 2,8 L6 - L8 - L10 - L11,5 - L13 - L15 3,2 L6 - L8 - L10 - L11,5 - L13 - L15 3,6 L6 - L8 - L10 4,2 L6	2,4 L6 - L8 - L10 - L11,5 - L13 - L15 2,8 L6 - L8 - L10 - L11,5 - L13 - L15 3,2 L6 - L8 - L10 - L11,5 - L13 - L15 3,6 L6 - L8 - L10 4,2 L6	/
	L18	2,4 L6 - L8 - L10 - L11,5 - L13 - L15 - L18 2,8 L6 - L8 - L10 - L11,5 - L13 - L15 3,2 L6 - L8 - L10 - L11,5 - L13 - L15 3,6 L6 - L8 - L10 4,2 L6	2,4 L6 - L8 - L10 - L11,5 - L13 - L15 - L18 2,8 L6 - L8 - L10 - L11,5 - L13 - L15 3,2 L6 - L8 - L10 - L11,5 - L13 - L15 3,6 L6 - L8 - L10 - L11,5 4,2 L6	2,4 L6 - L8 - L10 - L11,5 - L13 - L15 - L18 2,8 L6 - L8 - L10 - L11,5 - L13 - L15 3,2 L6 - L8 - L10 - L11,5 - L13 - L15 3,6 L6 - L8 - L10 - L11,5 4,2 L6	/

JDIcon Ultra S

IMPLANT DIAMETER	IMPLANT LENGTH	SOFT BONE TYPE IV	MEDIUM BONE TYPE II-III	DENSE BONE TYPE I
Ø 2,75	L6	/	/	/
	L8	2,0 L6 - L8	2,0 L6 - L8 2,4 L6 - L8	2,0 L6 - L8 2,4 L6 - L8 2,8 L6
	L10	2,0 L6 - L8 - L10	2,0 L6 - L8 - L10 2,4 L6 - L8 - L10	2,0 L6 - L8 - L10 2,4 L6 - L8 - L10 2,8 L6
	L11,5	2,0 L6 - L8 - L10 - L11,5	2,0 L6 - L8 - L10 - L11,5 2,4 L6 - L8 - L10 - L11,5	2,0 L6 - L8 - L10 - L11,5 2,4 L6 - L8 - L10 - L11,5 2,8 L6 - L8
	L13	2,0 L6 - L8 - L10 - L11,5 - L13	2,0 L6 - L8 - L10 - L11,5 - L13 2,4 L6 - L8 - L10 - L11,5 - L13	2,0 L6 - L8 - L10 - L11,5 - L13 2,4 L6 - L8 - L10 - L11,5 - L13 2,8 L6 - L8

JD Pterygo

IMPLANT DIAMETER	IMPLANT LENGTH	
Ø 3,3	L13	2,0 L6 - L8 - L10 - L11,5 - L13 2,4 L6 2,8 L6 (only for dense bone)
	L15	2,0 L6 - L8 - L10 - L11,5 - L13 - L15 2,4 L6 2,8 L6 (only for dense bone)
	L18	2,0 L6 - L8 - L10 - L11,5 - L13 - L15 - L18 2,4 L6 2,8 L6 (only for dense bone)
	L20	2,0 L6 - L8 - L10 - L11,5 - L13 - L15 - L18 - L20 2,4 L6 2,8 L6 (only for dense bone)
Ø 4,0	L13	2,4 L6 - L8 - L10 - L11,5 - L13 3,2 L6
	L15	2,4 L6 - L8 - L10 - L11,5 - L13 - L15 3,2 L6
	L18	2,4 L6 - L8 - L10 - L11,5 - L13 - L15 - L18 3,2 L6
	L20	2,4 L6 - L8 - L10 - L11,5 - L13 - L15 - L18 - L20 3,2 L6

JDEvolution S







IMPLANT DIAMETER	IMPLANT LENGTH	Site preparation in maxilla		Site preparation in mandible	
		SOFT BONE	MEDIUM-DENSE BONE	SOFT BONE	MEDIUM-DENSE BONE
Ø 3,2	L6	/	/	/	/
	L8	2,4 L6 - L8 2,8 L6	2,4 L6 - L8 2,8 L6 3,2 L6	2,4 L6 - L8 2,8 L6 3,2 L6	2,4 L6 - L8 2,8 L6 - L8 3,2 L6
	L10	2,4 L6 - L8 - L10 2,8 L6	2,4 L6 - L8 - L10 2,8 L6 3,2 L6	2,4 L6 - L8 - L10 2,8 L6 3,2 L6	2,4 L6 - L8 - L10 2,8 L6 - L8 - L10 3,2 L6
	L11,5	2,4 L6 - L8 - L10 - L11,5 2,8 L6	2,4 L6 - L8 - L10 - L11,5 2,8 L6 3,2 L6	2,4 L6 - L8 - L10 - L11,5 2,8 L6 - L8 3,2 L6	2,4 L6 - L8 - L10 - L11,5 2,8 L6 - L8 - L10 - L11,5 3,2 L6
	L13	2,4 L6 - L8 - L10 - L11,5 - L13 2,8 L6 - L8	2,4 L6 - L8 - L10 - L11,5 - L13 2,8 L6 - L8 3,2 L6	2,4 L6 - L8 - L10 - L11,5 - L13 2,8 L6 - L8 3,2 L6	2,4 L6 - L8 - L10 - L11,5 - L13 2,8 L6 - L8 - L10 - L11,5 - L13 3,2 L6
	L15	2,4 L6 - L8 - L10 - L11,5 - L13 - L15 2,8 L6 - L8	2,4 L6 - L8 - L10 - L11,5 - L13 - L15 2,8 L6 - L8 3,2 L6	2,4 L6 - L8 - L10 - L11,5 - L13 - L15 2,8 L6 - L8 3,2 L6	2,4 L6 - L8 - L10 - L11,5 - L13 - L15 2,8 L6 - L8 - L10 - L11,5 - L13 - L15 3,2 L6

JDNasal

IMPLANT DIAMETER	IMPLANT LENGTH	
Ø 4,0	L20	2,0 L6 - L8 - L10 - L11,5 - L13 - L15 - L18 - L20 2,4 L6 - L8 - L10 - L11,5 - L13 - L15 - L18 - L20 2,8 L6 - L8 - L10 - L11,5 - L13 3,2 L6 - L8 - L10 3,6 L6
	L22	2,0 L6 - L8 - L10 - L11,5 - L13 - L15 - L18 - L20 - L22 2,4 L6 - L8 - L10 - L11,5 - L13 - L15 - L18 - L20 - L22 2,8 L6 - L8 - L10 - L11,5 - L13 3,2 L6 - L8 - L10 3,6 L6
	L24	2,0 L6 - L8 - L10 - L11,5 - L13 - L15 - L18 - L20 - L22 - L24 2,4 L6 - L8 - L10 - L11,5 - L13 - L15 - L18 - L20 - L22 - L24 2,8 L6 - L8 - L10 - L11,5 - L13 3,2 L6 - L8 - L10 3,6 L6
	L26	2,0 L6 - L8 - L10 - L11,5 - L13 - L15 - L18 - L20 - L22 - L24 - L26 2,4 L6 - L8 - L10 - L11,5 - L13 - L15 - L18 - L20 - L22 - L24 - L26 2,8 L6 - L8 - L10 - L11,5 - L13 3,2 L6 - L8 - L10 3,6 L6

SUMMARY TABLES

All The Drills	60
All The instruments	64

		STANDARD KITS					
							
		EVPS	EVPCN	JDPS	JDPCN	JDBTK	JDODK
		JDPad Surgical Kit	JDPad Surgical Kit w/Drill Stops	JD Surgical Plastic Kit Standard	JD Surgical Plastic Kit w/ Drill Stops	JD Bone Track™ Drills Kit	JD Onedrill Kit
Fixation Pin	JDPIN						
Tissue Punch	JDTP35						
Implant Mounters	EVGMC						
	EVGMLC						
	ESGMC						
	ICGMC						
	ICGMC.						
Sleeves	JDBG						
	JDBGB						
	JDBGP						
Surgical Driver	EVSUDMAX						
JDTorque	JDTW	●	●	●	●		
	JDTWA	●	●	●	●		

		GUIDED SURGERY				MAXILLA-FOR-ALL®		
								
		JDGSK	JDKITO2	JDKITO4	JDKITO1	JDNAKF	ZSKITE	ZSKITF
		JD Guided Surgery Kit	JD Extra Drills Kit	JD Pterygo Surgical Kit	JD Pterygo Drills Kit	JD Nasal Kit	JD Zygoma Kit Extra	JD Zygoma Kit Full
	●							
	●							
	▲							
	▲							
	▲							
	▲							
	▲							
	▲							
	▲							
	■							
	■							
	■							
	●						●	●
	●							
	●							

● Included in the kit ▲ Provided in the kit compatible with the chosen implant line ■ Not included in the kit. To be ordered separately



JDENTALCARE

www.jdentalcare.com

JDentalCare, the JDentalCare logo and other trademarks mentioned in this document are, excluding specifically mentioned exceptions, trademarks property of JDentalCare.
The images of the products represented in this brochure are not necessarily to scale.

Note: Not all products manufactured by JDentalCare and represented in this brochure have been regulatory cleared/released for sale in all countries and/or have been licensed in accordance with FDA Rules and Regulations.
For more information about current product assortment and availability, please contact your local JDentalCare distributor. For prescription only.

Caution: Federal (US) law restricts this device to sale by or on the other for a licensed dentist. See instructions for use for more information such as indications, warnings, precaution and contraindications.

REV.00 of 2024-03-12