

TiBase, JDScanBody and Implant Replica CAD CAM:

ISSBCEC	ScanBody Engaging JDIcon Ultra S
EVCASBCEC	ScanBody Conical Abutment JDEvolution
EVCASBCEEC	ScanBody Engaging Conical Abutment
EVCASBCECSC:	On Top ScanBody Conical Abutment JDEvolution Plus*
ISTIBC	TiBase JDIcon Ultra S
ISTIBNC	TiBase New JDIcon Ultra S
ISTIB15NC	TiBase New H 1.5 JDIcon Ultra S
ISTIB30NC	TiBase New H 3.0 JDIcon Ultra S
EVCAITEC	Interface CAD CAM for Conical Abutment Engaging JDEvolution (H 7.5)
EVA139C	TiBase Engaging for Conical Abutment (H 5.0)
EVCAITC	Interface CAD CAM for Conical Abutment Non Engaging JDEvolution (H 7.3)
EVCATIBC	TiBase for Conical Abutment JDEvolution (H 5.0)
EVS110	Prosthetic Screw Conical Abutment Direct
EVS111	Prosthetic Screw Conical Abutment Direct Long
EVS112	Prosthetic Screw for Angulated Channel Conical Abutment Direct
ISANCN	Implant Replica CAD CAM New JDIcon Ultra S
ISPMNC	Pre-milled Abutment Blank JDIcon Ultra S

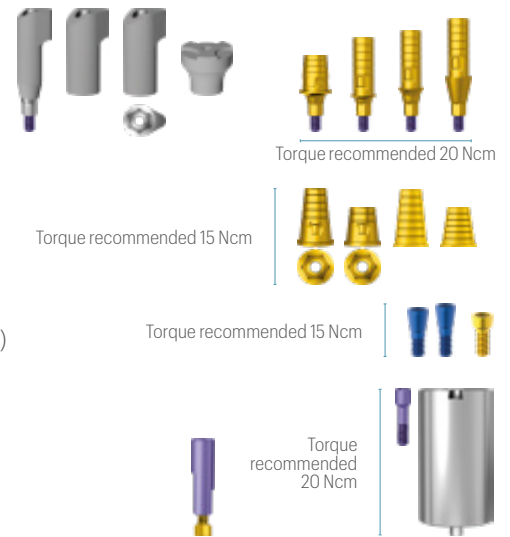

*for screw use JDEvolution plus prosthetic screwdriver

Ball Abutment:

ISBA15	Ball Abutment H 1.5 JDIcon Ultra S
ISBA30	Ball Abutment H 3.0 JDIcon Ultra S
ISBA50	Ball Abutment H 5.0 JDIcon Ultra S
EVBAA	Ball Abutment Replica
EVBAHC	Ball Abutment Elastic Retention Cap w/ Container
EVBAN	Ball Abutment Retention Cap



Implant Replica:

ISAN	Implant Replica JDIcon Ultra S
------	--------------------------------



Implant and Prosthetic Drivers:

ISID	Implant Driver JDIcon Ultra S
ISIDL	Implant Driver Long JDIcon Ultra S
EVSDPF15	Prosthetic Driver for JDTorque L 15
EVSDPF20	Prosthetic Driver for JDTorque L 20
EVSDPF25	Prosthetic Driver for JDTorque L 25
EVSDPF35	Prosthetic Driver for JDTorque L 35
EVSDPF60	Prosthetic Driver for JDTorque L 60
EVSDCAF	Conical Abutment Driver for JDTorque
EVSDP20	Prosthetic Driver L 20
EVSDP25	Prosthetic Driver L 25
EVSDP30	Prosthetic Driver L 30
JDPD103	Prosthetic Driver for Surgical Driver
EVSDCA	Conical Abutment Driver
EVSDPF25A	Angulated Screw Driver for JDTorque L 25
EVSDPF30A	Angulated Screw Driver for JDTorque L 30
EVSDPF25AV	Angulated Screw Driver for Conical Abutment Direct JDTorque L 25
EVSDPF30AV	Angulated Screw Driver for Conical Abutment Direct JDTorque L 30
JDG	JDGuide
ISGMC	Implant Mounter for JDIcon Ultra S

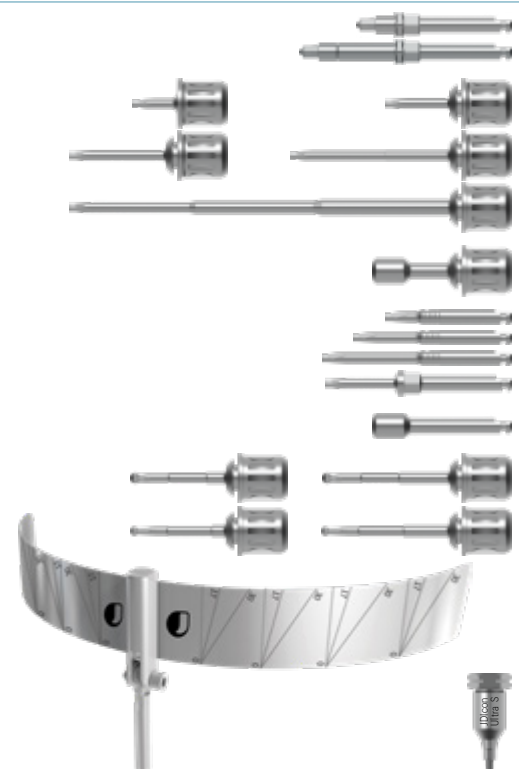

Direction indicators:

JDDI	Direction Indicator
JDDIS	Direction Indicator Short
JDDI17	Direction Indicator 17°





JDENTALCARE
just smile

JD ICON ultra.s

Smaller and stronger: Ø 2.75mm

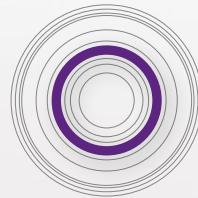

conical connection



FDA
Approved



Made in Italy

SMALLER AND STRONGER

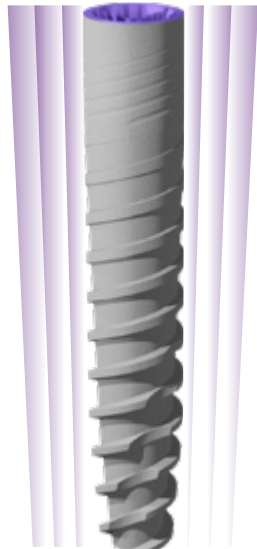

Ø 2,75mm

JDIcon Ultra S is a two-piece implant with 2.75mm diameter and internal conical connection.

It is one of the smallest implant with internal connection ever manufactured.

Despite its small diameter JDIcon Ultra.S provides a high strength due to its design and its tight conical connection.

PRODUCT SPECIFICATIONS

The JDIcon Ultra.S dental implants are available in the lengths shown in the following table:

IMPLANT DIAMETER	TIP DIAMETER	ABUTMENT INTERFACE	PLATFORM DIAMETER	LENGTH				
				8	10	11,5	13	15
Ø 2,75	1,95	2,3	2,75					

Note: all measurements in mm

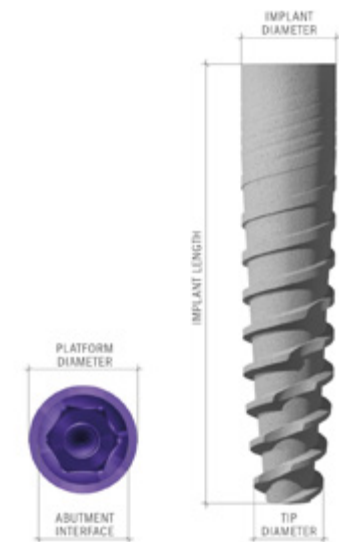

DRILLING SEQUENCE

It is recommended to adhere to the indications of the following drilling sequence to ensure optimal primary stability of the implant.

IMPLANT DIAMETER	SOFT BONE TYPE IV	MEDIUM BONE TYPE II-III	DENSE BONE TYPE I
Ø 2,75	1,5 2,0	2,0 2,4	2,0 2,4 2,8*

*Until the first laser mark

Note: all measurements in mm

Important:

JDIcon Ultra S Implant is designed to withstand a maximum insertion torque of 60Ncm. The JDIcon Ultra S prosthetic screws are designed to withstand a maximum insertion torque of 20Ncm.

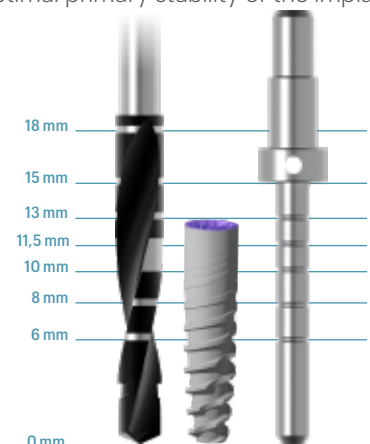

PRODUCT CATALOGUE

Implants:

Ø 2,75

IC27080	JDIcon Ultra S Ø 2.75 L 8
IC27100	JDIcon Ultra S Ø 2.75 L 10
IC27115	JDIcon Ultra S Ø 2.75 L 11.5
IC27130	JDIcon Ultra S Ø 2.75 L 13
IC27150	JDIcon Ultra S Ø 2.75 L 15

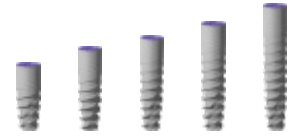

Cover Screw:

ISCS	Cover Screw JDIcon Ultra S
------	----------------------------



Healing Abutment:

ISHA323	Healing Abutment Ø 3.2 H 3.0 JDIcon Ultra S
ISHA325	Healing Abutment Ø 3.2 H 5.0 JDIcon Ultra S
ISHA327	Healing Abutment Ø 3.2 H 7.0 JDIcon Ultra S
ISHA403	Healing Abutment Ø 4.0 H 3.0 JDIcon Ultra S
ISHA405	Healing Abutment Ø 4.0 H 5.0 JDIcon Ultra S
ISHA407	Healing Abutment Ø 4.0 H 7.0 JDIcon Ultra S



Impression Coping:

OPEN TRAY

ISICOT32C	Impression Coping Open Tray Ø 3.2 JDIcon Ultra S
ISICOT40C	Impression Coping Open Tray Ø 4.0 JDIcon Ultra S

CLOSED TRAY

ISICCT32C	Impression Coping Closed Tray Ø 3.2 JDIcon Ultra S
ISICCT40C	Impression Coping Closed Tray Ø 4.0 JDIcon Ultra S

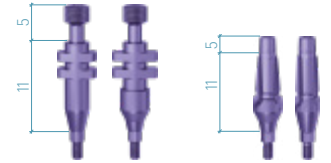

Prosthetic Screw:

ISS	Prosthetic Screw JDIcon Ultra S
ISSA	Prosthetic Screw Angulated JDIcon Ultra S

Torque recommended 20 Ncm



Temporary Abutment:

ISTAEC	Temporary Abutment Engaging JDIcon Ultra S
--------	--

Torque recommended 20 Ncm



GP Abutment:

ISGP32C	GP Abutment Ø 3.2 JDIcon Ultra S
ISGP40C	GP Abutment Ø 4.0 JDIcon Ultra S
IS15GPA40C	GP Abutment 15° Ø 4.0 JDIcon Ultra S

Torque recommended 20 Ncm



Cobalt-Chrome Abutment:

ISCCCEC	Cobalt-Chrome Abutment Engaging JDIcon Ultra S
EVCACCNEC	Cobalt-Chrome Conical Abutment Non Engaging JDEvolution

Torque recommended 20 Ncm

15 Ncm



Wax-Up Abutment:

ISWAEC	Wax-Up Abutment Engaging JDIcon Ultra S
--------	---

Torque recommended 20 Ncm



Straight Abutment:

ISSA4020C	Straight Abutment Ø 4.0 H 2.0 JDIcon Ultra S
ISSA4040C	Straight Abutment Ø 4.0 H 4.0 JDIcon Ultra S

Torque recommended 20 Ncm



Conical Abutment:

ISCA15C	Conical Abutment H 1.5 JDIcon Ultra S
ISCA1725C	Conical Abutment Angulated 17° H 2.5 JDIcon Ultra S
ISCASA	Conical Abutment Angulated Screw JDIcon Ultra S

Torque recommended 20 Ncm

