

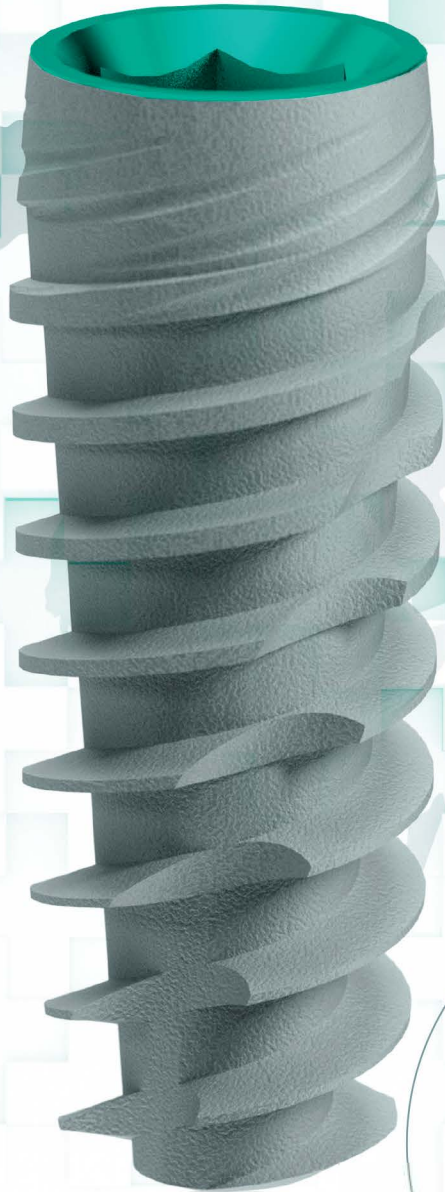

JDENTAL CARE

just smile



FDA
Approved



MADE IN ITALY

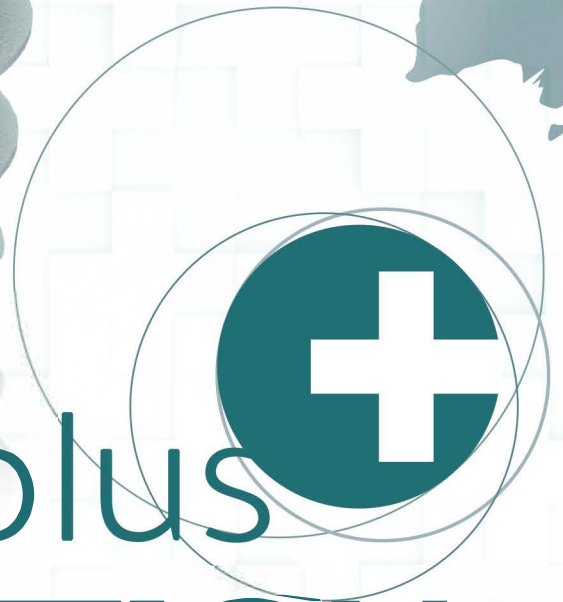

plus

Dental Implant

JD EVOLUTION

JD EVOLUTION PLUS+

SIMPLE INSERTION, NATURAL STABILITY.

FEATURES & ADVANTAGES

- Internal hex connection with lead-in bevel
- Anatomic coronal collar
- Expanding tapered inner body
- Self-cutting capacity in both directions
- Apical cutting blades
- The Connection is universally recognized by all the main CAD CAM platforms' libraries
- Reduces stress concentration on the crestal bone and maximizes bone volume around the implant neck for stable hard and soft tissue
- Makes it possible to achieve high primary stability with low torque and in compromised bone situations

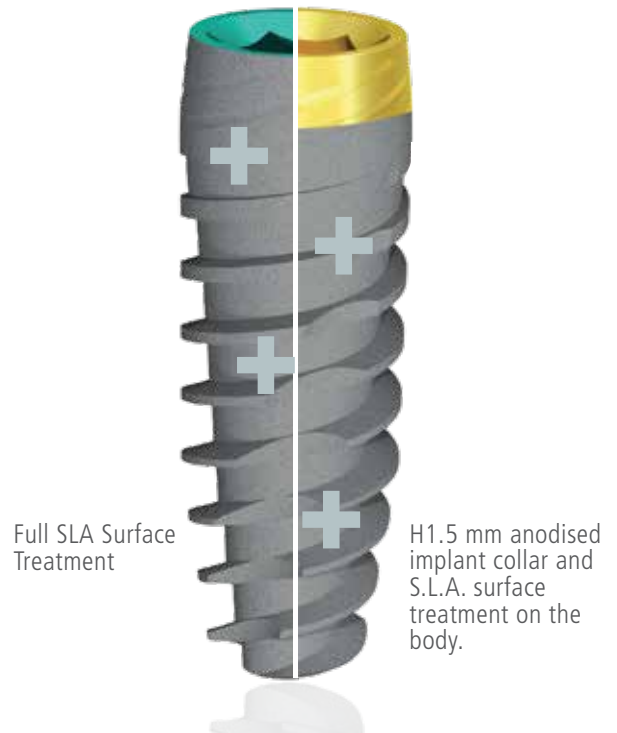

SINGLE PROSTHETIC CONNECTION.

Single prosthetic connection for all diameters, Ø 3.7, Ø 4.3, Ø 5.0, Ø 6.0. Reduced inventory and enhanced working flexibility.

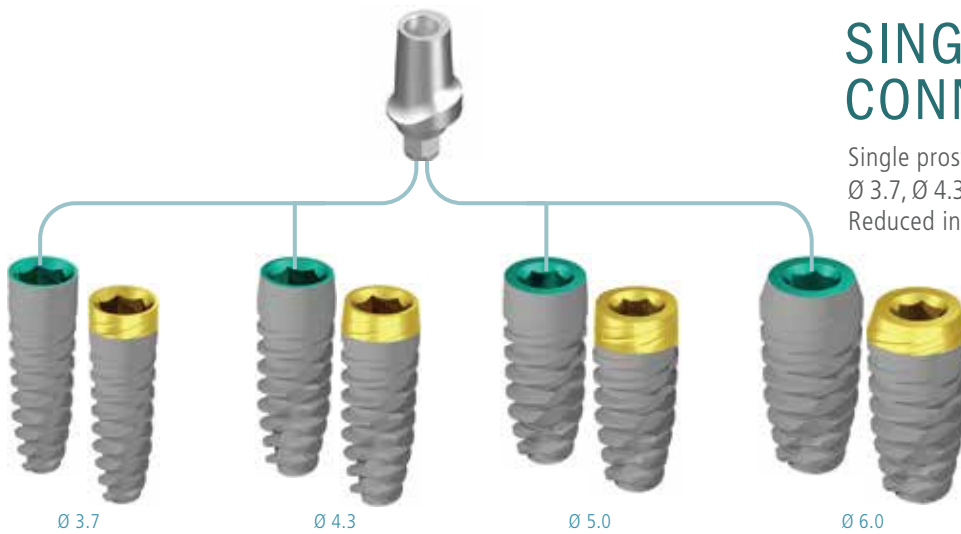

PRODUCT SPECIFICATIONS.

The JDEVOLUTION PLUS+ dental implant is available in the diameters and lengths shown in this chart:

IMPLANT DIAMETER	TIP DIAMETER	ABUTMENT INTERFACE	PLATFORM DIAMETER	LENGTH						
				6	8	10	11.5	13	15	18
Ø 3,7	2.4	3.4	3.7		8	10	11.5	13	15	18
Ø 4,3	2.8	3.4	4.0	6	8	10	11.5	13	15	18
Ø 5,0	3.2	3.4	4.8	6	8	10	11.5	13	15	18
Ø 6,0	4.8	3.4	5.0	6	8	10	11.5	13	15	

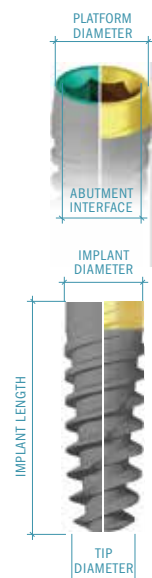

PRODUCT CATALOGUE

Implants:

Ø 3,7

EV37080:	JDEvolution Plus+ Ø 3.7 L 8
EV37100:	JDEvolution Plus+ Ø 3.7 L 10
EV37115:	JDEvolution Plus+ Ø 3.7 L 11.5
EV37130:	JDEvolution Plus+ Ø 3.7 L 13
EV37150:	JDEvolution Plus+ Ø 3.7 L 15
EV37180:	JDEvolution Plus+ Ø 3.7 L 18

Ø 4,3

EV43060:	JDEvolution Plus+ Ø 4.3 L 6
EV43080:	JDEvolution Plus+ Ø 4.3 L 8
EV43100:	JDEvolution Plus+ Ø 4.3 L 10
EV43115:	JDEvolution Plus+ Ø 4.3 L 11.5
EV43130:	JDEvolution Plus+ Ø 4.3 L 13
EV43150:	JDEvolution Plus+ Ø 4.3 L 15
EV43180:	JDEvolution Plus+ Ø 4.3 L 18

Ø 5,0

EV50060:	JDEvolution Plus+ Ø 5.0 L 6
EV50080:	JDEvolution Plus+ Ø 5.0 L 8
EV50100:	JDEvolution Plus+ Ø 5.0 L 10
EV50115:	JDEvolution Plus+ Ø 5.0 L 11.5
EV50130:	JDEvolution Plus+ Ø 5.0 L 13
EV50150:	JDEvolution Plus+ Ø 5.0 L 15
EV50180:	JDEvolution Plus+ Ø 5.0 L 18

Ø 6,0

EV60060:	JDEvolution Plus+ Ø 6.0 L 6
EV60080:	JDEvolution Plus+ Ø 6.0 L 8
EV60100:	JDEvolution Plus+ Ø 6.0 L 10
EV60115:	JDEvolution Plus+ Ø 6.0 L 11.5
EV60130:	JDEvolution Plus+ Ø 6.0 L 13
EV60150:	JDEvolution Plus+ Ø 6.0 L 15

Anodised Implant Collar

Ø 3,7

EVA37080:	JDEvolution Plus+ Anodized Collar Ø 3.7 L 8
EVA37100:	JDEvolution Plus+ Anodized Collar Ø 3.7 L 10
EVA37115:	JDEvolution Plus+ Anodized Collar Ø 3.7 L 11.5
EVA37130:	JDEvolution Plus+ Anodized Collar Ø 3.7 L 13
EVA37150:	JDEvolution Plus+ Anodized Collar Ø 3.7 L 15
EVA37180:	JDEvolution Plus+ Anodized Collar Ø 3.7 L 18

Ø 4,3

EVA43060:	JDEvolution Plus+ Anodized Collar Ø 4.3 L 6
EVA43080:	JDEvolution Plus+ Anodized Collar Ø 4.3 L 8
EVA43100:	JDEvolution Plus+ Anodized Collar Ø 4.3 L 10
EVA43115:	JDEvolution Plus+ Anodized Collar Ø 4.3 L 11.5
EVA43130:	JDEvolution Plus+ Anodized Collar Ø 4.3 L 13
EVA43150:	JDEvolution Plus+ Anodized Collar Ø 4.3 L 15
EVA43180:	JDEvolution Plus+ Anodized Collar Ø 4.3 L 18

Ø 5,0

EVA50060:	JDEvolution Plus+ Anodized Collar Ø 5.0 L 6
EVA50080:	JDEvolution Plus+ Anodized Collar Ø 5.0 L 8
EVA50100:	JDEvolution Plus+ Anodized Collar Ø 5.0 L 10
EVA50115:	JDEvolution Plus+ Anodized Collar Ø 5.0 L 11.5
EVA50130:	JDEvolution Plus+ Anodized Collar Ø 5.0 L 13
EVA50150:	JDEvolution Plus+ Anodized Collar Ø 5.0 L 15
EVA50180:	JDEvolution Plus+ Anodized Collar Ø 5.0 L 18

Ø 6,0

EVA60060:	JDEvolution Plus+ Anodized Collar Ø 6.0 L 6
EVA60080:	JDEvolution Plus+ Anodized Collar Ø 6.0 L 8
EVA60110:	JDEvolution Plus+ Anodized Collar Ø 6.0 L 10
EVA60115:	JDEvolution Plus+ Anodized Collar Ø 6.0 L 11.5
EVA60130:	JDEvolution Plus+ Anodized Collar Ø 6.0 L 13
EVA60150:	JDEvolution Plus+ Anodized Collar Ø 6.0 L 15



Cover screw:

EVCS:	Cover screw JDEvolution Plus+
EVCS6:	Cover screw Ø 6.0 JDEvolution Plus+



Healing Abutment:

EVHA43:	Healing Abutment Ø 4.0 H 3.0 JDEvolution Plus+
EVHA45:	Healing Abutment Ø 4.0 H 5.0 JDEvolution Plus+
EVHA47:	Healing Abutment Ø 4.0 H 7.0 JDEvolution Plus+
EVHA53:	Healing Abutment Ø 5.0 H 3.0 JDEvolution Plus+
EVHA55:	Healing Abutment Ø 5.0 H 5.0 JDEvolution Plus+
EVHA57:	Healing Abutment Ø 5.0 H 7.0 JDEvolution Plus+
EVHA59:	Healing Abutment Ø 5.0 H 9.0 JDEvolution Plus+
EVHA63:	Healing Abutment Ø 6.0 H 3.0 JDEvolution Plus+
EVHA65:	Healing Abutment Ø 6.0 H 5.0 JDEvolution Plus+
EVHA67:	Healing Abutment Ø 6.0 H 7.0 JDEvolution Plus+
EVHA753:	Healing Abutment Ø 7.5 H 3.0 JDEvolution Plus+
EVHA755:	Healing Abutment Ø 7.5 H 5.0 JDEvolution Plus+
EVHA54TS:	Tissue Lovers Healing Abutment Ø 5.0 H 4.0 JDEvolution Plus+
EVHA56TS:	Tissue Lovers Healing Abutment Ø 5.0 H 6.0 JDEvolution Plus+



Impression copings:

OPEN TRAY

EVICOT4C:	Impression coping open tray Ø 4.0 JDEvolution Plus+
EVICOT5C:	Impression coping open tray Ø 5.0 JDEvolution Plus+
EVICOT6C:	Impression coping open tray Ø 6.0 JDEvolution Plus+
EVICOTNEC:	Impression coping open tray non engaging JDEvolution Plus+
EVICOT5TSC:	Tissue Lovers Impression coping open tray Ø 5.0 JDEvolution Plus+



CLOSED TRAY

EVICCT4C:	Impression coping closed tray Ø 4.0 JDEvolution Plus+
EVICCT5C:	Impression coping closed tray Ø 5.0 JDEvolution Plus+
EVICCT6C:	Impression coping closed tray Ø 6.0 JDEvolution Plus+
EVICCT1C:	Impression coping closed tray direct press fit JDEvolution Plus+



Temporary Abutment:

EVTAE C:	Temporary Abutment engaging JDEvolution Plus+
EVTANEC:	Temporary Abutment non engaging JDEvolution Plus+
EVTAE TSC:	Tissue Lovers Temporary Abutment engaging JDEvolution Plus+
EVTANETSC:	Tissue Lovers Temporary Abutment non engaging JDEvolution Plus+



Straight Abutment:

EVNSA4520C:	Straight Abutment Ø 4.5 H 2.0 JDEvolution Plus+
EVNSA4540C:	Straight Abutment Ø 4.5 H 4.0 JDEvolution Plus+
EVNSA5020C:	Straight Abutment Ø 5.0 H 2.0 JDEvolution Plus+
EVNSA5040C:	Straight Abutment Ø 5.0 H 4.0 JDEvolution Plus+
EVNSA6020C:	Straight Abutment Ø 6.0 H 2.0 JDEvolution Plus+
EVNSA6040C:	Straight Abutment Ø 6.0 H 4.0 JDEvolution Plus+
EVNSA5020TSC:	Tissue Lovers Straight Abutment Ø 5.0 H 2.0 JDEvolution Plus+
EVNSA5040TSC:	Tissue Lovers Straight Abutment Ø 5.0 H 4.0 JDEvolution Plus+



GP Abutment:

EVGPA40EC:	Gp Abutment engaging Ø 4.0 JDEvolution Plus+
EVGPA40NEC:	Gp Abutment non engaging Ø 4.0 JDEvolution Plus+
EVGPAEC:	Gp Abutment engaging Ø 5.0 JDEvolution Plus+
EVGPA50NEC:	Gp Abutment non engaging Ø 5.0 JDEvolution Plus+
EVGPA60EC:	Gp Abutment engaging Ø 6.0 JDEvolution Plus+



Angulated Abutment:

EV15A15:	15° Angulated Anatomic Abutment Ø 5.0 H 1.5 JDEvolution Plus+
EV15A15N:	15° Angulated Anatomic Abutment Small Ø 4.5 H 1.5 JDEvolution Plus+
EV15A30:	15° Angulated Anatomic Abutment Ø 5.0 H 3.0 JDEvolution Plus+
EV15A30N:	15° Angulated Anatomic Abutment Small Ø 4.5 H 3.0 JDEvolution Plus+
EV25A15:	25° Angulated Anatomic Abutment Ø 5.0 H 1.5 JDEvolution Plus+
EV25A30:	25° Angulated Anatomic Abutment Ø 5.0 H 3.0 JDEvolution Plus+



Rapid Abutment:

EVRA15C:	Rapid Abutment H 1.5 JDEvolution Plus+
EVRA30C:	Rapid Abutment H 3.0 JDEvolution Plus+
EVRAHC	Healing cap Rapid Abutment JDEvolution Plus+
EVRAIC	Coping Rapid abutment JDEvolution Plus+
EVRAAR	Abutment replica rapid abutment

Torque recommended 30 Ncm



Wax up Abutment:

EVWAEC:	Wax-up Abutment engaging JDEvolution Plus+
EVWANEC:	Wax-up Abutment non engaging JDEvolution Plus+

Torque recommended 30 Ncm

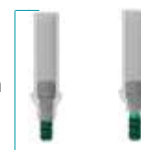

Cobalt-Chrome Abutment:

EVCCCEC:	Cobalt-Chrome Abutment engaging JDEvolution Plus+
EVCCNEC:	Cobalt-Chrome Abutment non engaging JDEvolution Plus+

Torque recommended 30 Ncm



Gold Abutment:

EVGAEC:	Gold Abutment engaging JDEvolution Plus+
EVGANEC:	Gold Abutment non engaging JDEvolution Plus+

Torque recommended 30 Ncm



Conical Abutment:

EVNCA15C:	Straight Conical Abutment H 1.5 JDEvolution Plus+
EVNCA30C:	Straight Conical Abutment H 3.0 JDEvolution Plus+
EVNCA70C:	Straight Conical Abutment H 7.0 JDEvolution Plus+
EVNCA90C:	Straight Conical Abutment H 9.0 JDEvolution Plus+
EVNCA15TSC:	Tissue Lovers Straight Conical Abutment H 1.5 JDEvolution Plus+
EVNCA30TSC:	Tissue Lovers Straight Conical Abutment H 3.0 JDEvolution Plus+
EVNCA40TSC:	Tissue Lovers Straight Conical Abutment H 4.0 JDEvolution Plus+
EVNCA50TSC:	Tissue Lovers Straight Conical Abutment H 5.0 JDEvolution Plus+
EVCA1725C:	17° angulated Conical Abutment H 2.5 JDEvolution Plus+
EVCA1735C:	17° angulated Conical Abutment H 3.5 JDEvolution Plus+
EVCA3025C:	30° angulated Conical Abutment H 2.5 JDEvolution Plus+
EVCA3035C:	30° angulated Conical Abutment H 3.5 JDEvolution Plus+

Torque recommended 30 Ncm

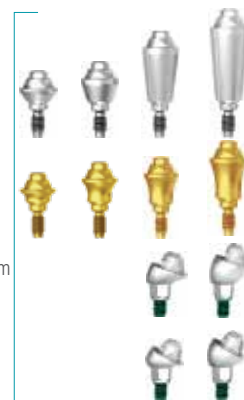

EVCAPS:	Prosthetic screw Conical Abutment JDEvolution Plus+
EVCASA:	Screw for angulated Conical Abutment JDEvolution Plus+
EVCAPSA	Prosthetic screw angulated channel for Conical Abutment

Torque recommended 15 Ncm

Torque recommended 30 Ncm

Torque recommended 15 Ncm

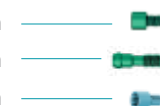

EVCAICOTEC:	Impression coping open tray Conical Abutment engaging JDEvolution Plus+
-------------	---

EVCAICOTC:	Impression coping open tray Conical Abutment JDEvolution Plus+
------------	--

EVCAICOTLC:	Impression coping open tray H12 Conical Abutment JDEvolution Plus+
-------------	--

EVCAICTC	Impression coping closed tray Conical Abutment
----------	--

EVCAHCL:	Healing cap Conical Abutment H 6.0 JDEvolution Plus+
----------	--

EVCAHC:	Healing cap Conical Abutment H 3.5 JDEvolution Plus+
---------	--

EVCAHCB:	Healing cap peek Conical Abutment H 3.5 JDEvolution Plus+
----------	---

EVCAGPAEC:	GP for Conical Abutment engaging JDEvolution Plus+
------------	--

EVCAGPANEC:	GP for Conical Abutment non engaging JDEvolution Plus+
-------------	--

EVCATANEWSC:	Temporary abutment smooth for welding conical abutment JDEvolution Plus+
--------------	--

Torque recommended 15 Ncm

EVCATANEC:	Temporary cylinder non engaging Conical Abutment JDEvolution Plus+
------------	--

EVCATANEWC:	Temporary cylinder non engaging Conical Abut. for welding JDEvolution Plus+
-------------	---

EVCAWANEC:	Wax up cylinder Conical Abutment non engaging JDEvolution Plus+
------------	---

EVCAAR	Abutment replica Conical Abutment
--------	-----------------------------------



Prosthetic screw:

EVS:	Abutment Screw JDEvolution Plus+
EVSA:	Abutment screw angulated channel JDEvolution Plus+

Torque recommended 30 Ncm



Interfaces:

EVINTEC:	Interface engaging for JDEvolution Plus+
EVINTNEC:	Interface non engaging for JDEvolution Plus+
70287C:	Interface non engaging for Conical Abutment JDEvolution Plus+

Torque recommended 30 Ncm

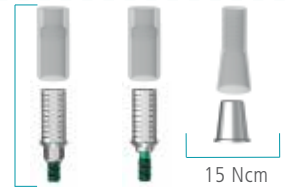

AS Abutment:

EVASCEC:	AS Abutment engaging for JDEvolution Plus+
EVASCNEC:	AS Abutment non engaging for JDEvolution Plus+

Torque recommended 30 Ncm

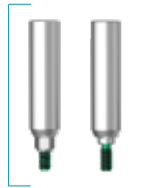

TiBase, ScanPost, JDScanBody and Implant Replica CAD CAM:

EVSBCEC:	JDScanBody for JDEvolution Plus+
EVCASBCEC:	JDScanBody for Conical Abutment
EVSCPC:	ScanPost JDEvolution Plus+
EVTIBC:	TiBase engaging Ø4.25 H 0.5 C 4.7 JDEvolution Plus+
EVTIBNEC:	TiBase non engaging Ø4.25 H 0.5 C 4.7 JDEvolution Plus+
EVTIB15C:	TiBase engaging Ø4.25 H 1.5 C 4.7 JDEvolution Plus+
EVTIB15NEC:	TiBase non engaging Ø4.25 H 1.5 C 4.7 JDEvolution Plus+
EVTIB30C:	TiBase engaging Ø4.25 H 3.0 C 4.7 JDEvolution Plus+
EVTIB30NEC:	TiBase non engaging Ø4.25 H 3.0 C 4.7 JDEvolution Plus+
EVTIBNC:	TiBase engaging long Ø4.4 H 0.5 C 7.7 JDEvolution Plus+
EVTIBNENC:	TiBase non engaging long Ø4.4 H 0.5 C 7.7 JDEvolution Plus+
EVTIB15NC:	TiBase engaging long Ø4.4 H 1.5 C 7.7 JDEvolution Plus+
EVTIB15NENC:	TiBase non engaging long Ø4.4 H 1.5 C 7.7 JDEvolution Plus+
EVTIB30NC:	TiBase engaging long Ø4.4 H 3.0 C 7.7 JDEvolution Plus+
EVTIB30NENC:	TiBase non engaging long Ø4.4 H 3.0 C 7.7 JDEvolution Plus+
EVTIB15TSC:	Tissue Lovers TiBase engaging Ø4.25 H 1.5 C 4.7 JDEvolution Plus+
EVTIB15NETSC:	Tissue Lovers TiBase non engaging Ø4.25 H 1.5 C 4.7 JDEvolution Plus+
EVTIB30TSC:	Tissue Lovers TiBase engaging Ø4.25 H 3.0 C 4.7 JDEvolution Plus+
EVTIB30NETSC:	Tissue Lovers TiBase non engaging Ø4.25 H 3.0 C 4.7 JDEvolution Plus+
EVSCBOW	ScanBody for TiBase
EVCAITEC:	Interface CAD CAM engaging for Conical Abutment H 7.5
EVCAITC:	Interface CAD CAM for Conical Abutment H 7.5
EVCATIBC:	Interface CAD CAM for Conical Abutment H 5.0
EVANCN:	DAS*Implant Replica CAD CAM for JDEvolution Plus+
EVCAARCN	DAS*Abutment Replica CAD CAM for Conical Abutment
EVPMNC:	JD Pre-milled blanks and abutment screw JDEvolution Plus+

*Direct Analog Screw

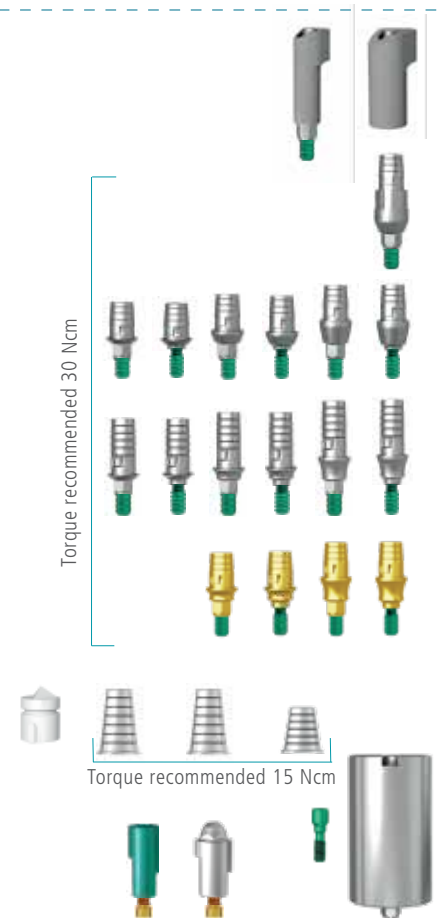

Note: Please contact info@jidentalcare.com for the digital library for Exocad, 3Shape and Dental Wings software.

Ball Abutment:

EVBA15:	Ball Abutment H 1.5 JDEvolution Plus+
EVBA30:	Ball Abutment H 3.0 JDEvolution Plus+
EVBA50:	Ball Abutment H 5.0 JDEvolution Plus+
EVBAA	Ball Abutment replica
EVBAHC	Cap attachment housing and elastic retentive cap Ball Abutment
EVBAN	Elastic retentive cap Ball Abutment

Torque recommended 30 Ncm



Implant replica:

EVAN:	Implant replica JDEvolution Plus+
-------	-----------------------------------



Emi Abutment:

EVEMI15:	Emi Abutment H 1.5 JDEvolution Plus+
EVEMI30:	Emi Abutment H 3.0 JDEvolution Plus+
EVEMI50:	Emi Abutment H 5.0 JDEvolution Plus+
EVEMISCK	Smart cap attachment housing Emi Abutment
EVEMIHC	Cap attachment housing and elastic retentive cap Emi Abutment
EVEMIN	Elastic retentive cap standard Emi Abutment - Retention 1,2 Kg
EVEMIH	Cap attachment housing Emi Abutment
EVEMIIIC	Impression coping Plastic for Emi Abutment
EVEMIIICS	Impression coping Steel for Emi Abutment
EVEMINT	Elastic retentive cap white Emi Abutment - Retention 1,8 Kg
EVEMINY	Elastic retentive cap yellow Emi Abutment - Retention 0,6 Kg
EVEMINP	Elastic retentive cap purple Emi Abutment - Retention 2,5 Kg
EVEMINB	Elastic retentive cap for laboratory Emi Abutment
EVEMIA	Emi Abutment analog
EVEMIIET	Insertion and Extractor Tool for Caps Emi Abutment

Torque recommended 30 Ncm



Bone Mills:

JDBMNNC:	Bone Mill Ø 5.0 and Bone Mill guide JDEvolution Plus+
JDBM6NC:	Bone Mill Ø 6.0 and Bone Mill guide JDEvolution Plus+
JDBMGN:	Bone Mill guide JDEvolution Plus+



Implant and prosthetic drivers:

EVID:	Implant driver JDEvolution Plus+
EVIDL:	Implant driver long JDEvolution Plus+
EVSDPF15:	Screwdriver hex 1.27 for torque wrench L15 JDEvolution Plus+
EVSDPF20:	Screwdriver hex 1.27 for torque wrench L20 JDEvolution Plus+
EVSDPF25:	Screwdriver hex 1.27 for torque wrench L25 JDEvolution Plus+
EVSDPF35:	Screwdriver hex 1.27 for torque wrench L35 JDEvolution Plus+
EVSDCAF	Screwdriver torque wrench Conical Abutment
EVSDP20:	Screwdriver hex 1.27 machine prosthetic L20 JDEvolution Plus+
EVSDP25:	Screwdriver hex 1.27 machine prosthetic L25 JDEvolution Plus+
EVSDP30:	Screwdriver hex 1.27 machine prosthetic L30 JDEvolution Plus+
EVSDCA	Screwdriver machine Conical Abutment
EVSDPF25A	Screwdriver screw angulated for torque wrench L25
EVSDPF30A	Screwdriver screw angulated for torque wrench L30
JDG	JD Guide for the full arch implant surgery
EVAMT:	Conical Abutment Aligning Instrument for JD Evolution Plus+
EVSUD	JD Surgical Driver



Direction indicator:

JDDI	Direction indicator JDEvolution Plus+
JDDIS	Short direction indicator JDEvolution Plus+
JDDI17	17° Angulated direction indicator JDEvolution Plus+
JDDI30	30° Angulated direction indicator JDEvolution Plus+
JDDI45	45° Angulated direction indicator JDEvolution Plus+



JD EVOLUTION PLUS+ DRILLING PROTOCOLS.

It is recommended to adhere to the indications of the following drilling sequence to ensure optimal primary stability of the implant.

Site preparation in maxilla.

IMPLANT DIAMETER	HEALED BONE		POST EXTRACTIVE BONE	
	SOFT BONE	MEDIUM-DENSE BONE	SOFT BONE	MEDIUM-DENSE BONE
Ø 3,7	2.0	2.0	2.0	2.0
	2.4	2.4	2.4	2.4
	2.8	2.8	2.8 at the entrance	2.8 at the entrance
	up to the first laser mark L6mm	up to the first laser mark L6mm		
	3.2	3.2		
Ø 4,3	2.0	2.0	2.0	2.0
	2.4	2.4	2.4	2.4
	2.8	2.8	2.8	2.8
	3.2	3.2	3.2 at the entrance	3.2 at the entrance
	at the entrance	up to the first laser mark L6-8mm		
	3.6	3.6		
Ø 5,0	2.0	2.0	2.0	2.0
	2.4	2.4	2.4	2.4
	2.8	2.8	2.8	2.8
	3.2	3.2	3.2	3.2
	3.6	3.6	3.6	3.6
	up to the first laser mark L6mm	up to the first laser mark L6mm	at the entrance up to the first laser mark L6mm	at the entrance up to the first laser mark L6mm
	4.0	4.0		
Ø 6,0	2.0	2.0	2.0	2.0
	2.4	2.4	2.4	2.4
	2.8	2.8	2.8	2.8
	3.2	3.2	3.2	3.2
	3.6	3.6	3.6	3.6
		4.0	4.0	4.0
		4.4		
		up to the first laser mark L6mm		



Site preparation in mandible.

IMPLANT DIAMETER	HEALED BONE		POST EXTRACTIVE BONE	
	SOFT BONE	MEDIUM-DENSE BONE	SOFT BONE	MEDIUM-DENSE BONE
Ø 3,7	2.0	2.0	2.0	2.0
	2.4	2.4	2.4	2.4
	2.8	2.8	2.8	2.8
	3.2	3.2	3.2 at the entrance	3.2 at the entrance
	3.6	3.6		
	up to the first laser mark L6mm	up to the first laser mark L6mm		
Ø 4,3	2.0	2.0	2.0	2.0
	2.4	2.4	2.4	2.4
	2.8	2.8	2.8	2.8
	3.2	3.2	3.2	3.2
	3.6	3.6	3.6 at the entrance	3.6 at the entrance
	4.0	4.0		
	up to the 2nd laser mark L8mm	up to the 2nd laser mark L8mm		
Ø 5,0	2.0	2.0	2.0	2.0
	2.4	2.4	2.4	2.4
	2.8	2.8	2.8	2.8
	3.2	3.2	3.2	3.2
	3.6	3.6	3.6	3.6
	4.0	4.0	4.0 at the entrance	4.0 at the entrance
	4.4	4.4		
	4.8	4.8		
	at the entrance	at the entrance		
Ø 6,0	2.0	2.0	2.0	2.0
	2.4	2.4	2.4	2.4
	2.8	2.8	2.8	2.8
	3.2	3.2	3.2	3.2
	3.6	3.6	3.6	3.6
	4.0	4.0	4.0	4.0
	4.4	4.4	4.4	4.4
	4.8	4.8		
	for the first 8mm	for the first 8mm		

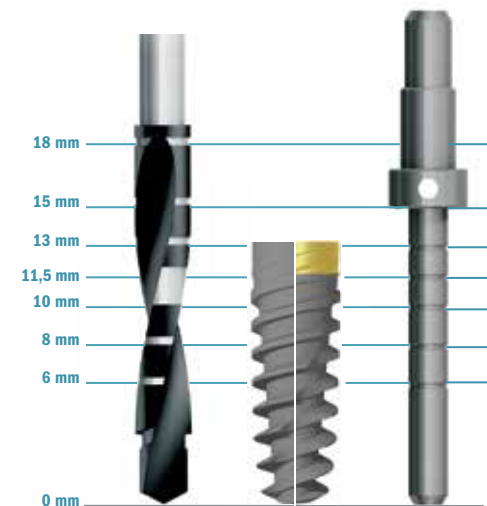

Note: All dimensions are expressed in millimetres.